



Rijksdienst voor Ondernemend
Nederland

Ontwerp van fotovoltaïsch-thermische zonnepanelen / Design of a PV-Thermal panel

EOS-LT Waels

Datum Maart 2009

ECN, Universiteit Twente, M.B.Timmerman

In opdracht van SenterNovem (nu Rijksdienst voor
Ondernemend Nederland)

Publicatienr RVO-155-1501/RP-DUZA
www.rvo.nl

Dit rapport is tot stand gekomen in opdracht van het ministerie van
Economische Zaken.

Design of a PV-Thermal panel

Integrated design with solar energy technologies



This report is intended for Energy Research Centre of the Netherlands (ECN) and the master programs Industrial Design Engineering and Sustainable Energy Technology of the University of Twente.

Energy Research Centre of the Netherlands (ECN)
Energy in the Built Environment and Grids
P.O. 1
1755 ZG Petten
0224 – 56 49 49



University of Twente
Faculty of Engineering Technology
P.O. 217
7500 AE Enschede
053 - 489 91 11



Design of a PV-Thermal panel

Integrated design with solar energy technology

M.B. Timmerman
s0044652

Examination board:
Prof. dr. ir. T.H. van der Meer
Prof. dr. ir. A. De Boer
Dr. A.H.M.E. Reinders
Drs. M. Bakker (ECN)

March 2009

Impression: 8 pieces, 90 pages, 8 appendices
Report number: opm-908

This report is written within the framework of the master theses Industrial Design Engineering and Sustainable Energy Technology.

Summary

Photovoltaic-thermal solar panels or PVT panels generate electricity and heat for hot tap water simultaneously. Until now, development has mainly focused on improving technology. However, for successful industrial product design, more topics need to be considered. Within this thesis PVT panels are designed where specific attention is paid to user requirements, costs, manufacturing, building integration and installation. The panels are designed for residential buildings with sloped roofs.

To support the design process the built environment and the building process have been analysed and an inventory is made of the requirements of architects, installers, and occupants. Several concepts for PVT panels were generated. Next, simulations of energetic performances demonstrated that plastic PVT panels can be as good as the currently used metal panels. Because of plastics' low weight and flexibility in shaping, a plastic PVT panel has been selected for further elaboration, where special attention is paid to the ease of installation.

The detailed design consists of a PV laminate glued on top of a plastic channel absorber. The panel is covered by a plastic layer to reduce heat losses. It is equipped with four connection points which enhance the flexibility of the positioning of PVT panels on a tilted roof. Because of this feature the installation process will be simplified and installation costs will be decreased. Since part of the production process can be automated, production costs can be decreased as well. In the Netherlands at an irradiation of 1,000 kWh/m².year, the PVT panel is expected to yield 96 kWh/m² of electricity and 0.95 GJ/m² of heat.

Fotovoltaïsch-thermische zonnepanelen of PVT panelen leveren zowel elektriciteit als warmte voor tapwater. Tot nu toe is de ontwikkeling van PVT panelen vooral gericht op het verbeteren van de technologie. Voor een succesvol industrieel productontwerp moeten echter meer onderwerpen beschouwd worden. In deze master opdracht zijn PVT panelen ontworpen waarbij speciale aandacht is besteed aan gebruikerseisen, kosten, productie, gebouwingegratie en installatie. De panelen zijn ontworpen voor huizen met schuine daken.

Om het ontwerpproces te ondersteunen zijn de gebouwde omgeving en het bouwproces geanalyseerd en zijn de eisen geïnventariseerd van architecten, installateurs, en bewoners. Verschillende concepten voor PVT panelen zijn ontwikkeld. Daarna zijn er simulaties uitgevoerd om de energieprestaties te vergelijken, waaruit blijkt dat plastic PVT panelen even goed kunnen presteren als de tot nu toe gebruikte metalen panelen. Vanwege het lage gewicht en de vormvrijheid van kunststoffen, is een plastic PVT paneel gekozen voor verdere detaillering. Hierbij is speciale aandacht besteed aan een eenvoudige installatie.

Het gedetailleerde ontwerp bestaat uit een PV laminaat gelijmd op een plastic kanaalabsorber. Het paneel is afgedekt met een plastic laag om de warmteverliezen te beperken. Vier aansluitpunten zorgen voor flexibiliteit in de positionering van de panelen op het dak. Hierdoor wordt het installatieproces vereenvoudigd en zullen de installatiekosten dalen. Doordat de productie gedeeltelijk geautomatiseerd kan worden, zullen ook de productiekosten dalen. In Nederland, bij een instraling van 1.000 W/m².jaar is te verwachten dat het PVT paneel 96 kWh/m² elektriciteit en 0.95 GJ/m².jaar warmte opwekt.

Contents

Summary	3
Preface.....	7
1. Introduction.....	9
1.1. Objective of the thesis	9
1.2. Scope	10
1.3. Structure of this report	10
Part I: Analysis	
2. Solar energy systems.....	15
2.1. Solar energy	15
2.2. Solar thermal collectors	16
2.3. Photovoltaic modules.....	17
2.4. PVT panels	18
2.4.1. Working principle	18
2.4.2. PVT market	20
2.4.3. PVT research.....	21
2.5. Conclusions for design	22
3. Built environment.....	24
3.1. Housing stock	24
3.2. Roof construction.....	25
3.3. Building integrated solar panels	26
3.4. Conclusions for design	27
4. Actor analysis.....	28
4.1. Building process.....	28
4.2. Main actors	30
4.2.1. Installation companies	30
4.2.2. Architects	31
4.2.3. Occupants	32
4.3. Conclusions for design	33
5. Program of requirements	34
5.1. Primary functioning.....	34
5.2. Context.....	34
5.3. Legislation and safety	34
5.4. Building integration	35
5.5. Installation	35
5.6. Manufacturing and storage.....	36
5.7. Operation and maintenance	36
Part II: Design	
6. Generation of ideas.....	39
6.1. Brainstorm techniques.....	39
6.2. Morphological framework	39
7. Idea detailing	43
7.1. Connection points	43
7.2. Joining system	45
7.3. Physical working principle.....	47
7.3.1. Model for simulation.....	48
7.3.2. Simulation settings	50
7.3.3. Simulation results	52
7.3.4. Conclusions and recommendations	54
7.4. Conclusions for design	55
8. Concept design	56
8.1. Concept Traditional.....	56
8.2. Concept Plastic	58
8.3. Concept Skylight.....	60
8.4. Concept choice	62

9. Detailed design	64
9.1. Construction of the panel.....	64
9.1.1. Components of the panel	65
9.1.2. Installation	70
9.2. Design considerations.....	73
9.2.1. Joining system.....	73
9.2.2. Dimensions	74
9.2.3. Number of panels.....	76
9.2.4. Colouring.....	76
 Part III: Evaluation	
10. Product overview.....	79
10.1. Product presentation	79
10.2. Unique selling points.....	81
10.3. Specifications.....	82
10.4. Product evaluation.....	83
10.5. Further steps towards market introduction.....	84
11. Conclusions and recommendations	85
References.....	87
Appendix A. Solar energy systems	93
A.I. Solar thermal collectors.....	93
A.I.I. Working principle	93
A.I.II. Purchase	98
A.I.III. Future research.....	99
A.II. PV systems	99
A.II.I. Working principle	99
A.II.II. Purchase	101
A.II.III. Future research.....	103
Appendix B. Visit to PVT installation in Overdie – Alkmaar.....	104
B.I. Installation.....	105
B.II. Remarks.....	107
Appendix C. Visit to installation company Solar-id – Bodegraven.....	108
Appendix D. Questionnaire interviews with architects	110
Appendix E. Idea generation	114
Appendix F. Simulation of different PVT principles.....	120
Appendix G. SUNTECH PV cells characteristics	121
Appendix H. Anthropometric analyses for installation	122

Preface

For a year I have worked on my master thesis at the Energy Research Center of the Netherlands (ECN) in Petten. ECN is the largest energy research institute in the Netherlands and employs about 900 people. Its mission is to develop high-level knowledge and technology for a sustainable energy system and transfer these to the market.

My work has taken place within the unit *Energy in the Built Environment and Grids*. The focus of this unit is on the application of sustainable energy in the built environment and the design of intelligent energy grids. Since January 2009 the unit *Energy in the Built Environment and Grids* is merged with the unit *Energy Efficiency in the Industry* to the new unit *Efficiency and Infrastructure*.

In 2004 the ECN spin-off company PVTwins is founded, which researches and manufactures photovoltaic-thermal (PVT) panels. In 2008 the company is taken over by ZEN International. The PVT panels of PVTwins have been the starting point of my thesis.

I would like to thank my colleagues of the unit *Energy in the Built Environment and Grids* for a pleasant working environment. In particular I would like to thank Marco Bakker for supervising my work and Herbert Zondag for his assistance with the simulations. Furthermore, I would like to thank Marcel Elswijk, founder of PVTwins, for his coaching and pointing out all problems that can be experienced in practise.

Mieke Timmerman
March 2009

1. Introduction

In the built environment solar energy can be used to generate both heat and electricity. Solar thermal collectors generate heat for space heating and hot tap water and photovoltaic (PV) modules generate electricity for domestic applications. A photovoltaic-thermal (PVT) panel is a combination of both systems and therefore generates heat and electricity simultaneously.

PVT panels have a number of advantages over the use of thermal collectors and PV modules next to each other. First of all, PVT panels have a higher overall yield than separate thermal and PV panels. Secondly PVT panels provide more architectural uniformity on the roof. Furthermore it is expected that PVT panels will have lower material and installation costs due to the combination of functions.

1.1. Objective of the thesis

The development of PVT panels has mainly been a technical story so far. Gaining a high(er) yield has been the first priority, later on followed by manufacturability. Looking at the four leaf clover model of industrial product design – see Figure 1 – technology is only one of the topics to be considered. Design & styling, ergonomics, and marketing are the other topics needed for a successful product design. All four topics should be considered to be equally important.

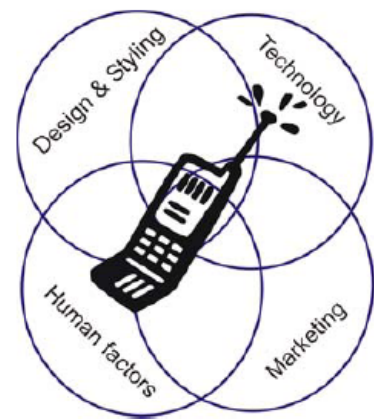

Figure 1: Four leaf clover model of industrial design engineering [1]

The objective of this master thesis is to design a PVT panel where attention is paid to user requirements, building integration, roof installation, costs, and manufacturability, without losing touch with the technical aspects. The panel will be designed for usage in the Netherlands and preferably also in other Western European countries in the year 2020. This will be done following the industrial design method of Pahl and Beitz as depicted in Figure 2.

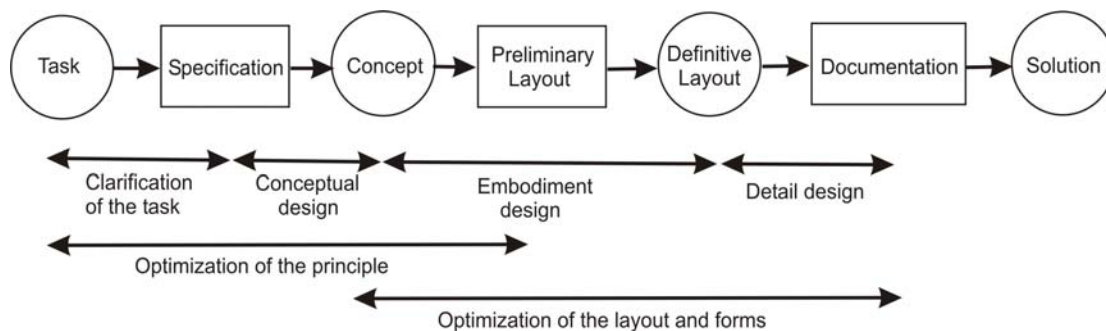

Figure 2: Model of Pahl and Beitz's industrial design method [1]

The PVT panel which is developed and prototyped by ECN – see Figure 4 – is used as a reference panel. This panel has also been the starting point of the company PVTwins. The design of the new panel may be based on the reference panel, but it may also be completely different. In the end, the new panel design will be compared to the reference panel, of which the characteristics are listed in Table 2 in section 2.5.

1.2. Scope

In this thesis the focus is on the design of the PVT *panel*. To connect to the rest of the system, the pipes and cables that go through the roof to the storage vessel and the inverter are also included in the design. Also the connection between the different panels and the roof is within the scope of this thesis.

To clearly describe which components are within the scope of this thesis, distinction has to be made between the PVT panel, the PVT system, and the building's hot water system, as shown in Figure 3.

- The **PVT panel** is the module on the outside of the building.
- The **PVT system** consists of the panel plus the installation components needed to get the hot water and electricity to the place of use. This includes the pipes and cables that go through the roof, the inverter, drain back vessel, and the collector pump.
- The **hot water system** of the building consists of the regular hot water installation, including the storage vessel and central heater.

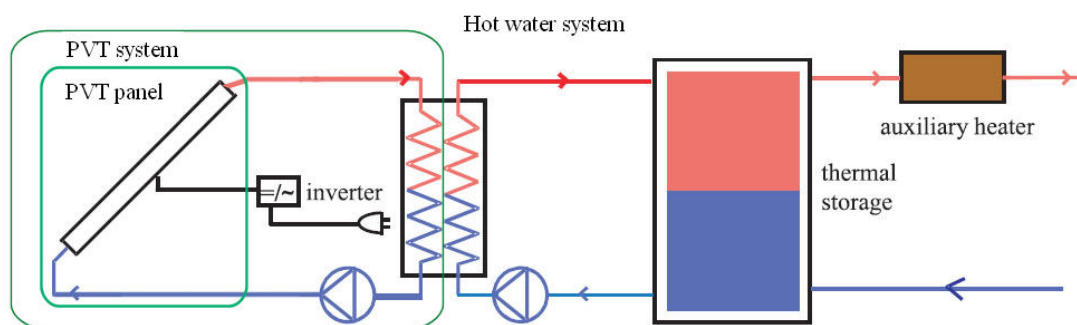

Figure 3: System boundaries (based on [2])

The green line around the PVT panel indicates the scope of this thesis. The design of the PVT system and the hot water system are outside the scope.

1.3. Structure of this report

The thesis is divided into three main parts: analysis, design, and evaluation. In the first part the focus is on analysing the context of PVT panels. The analysis phase concludes with a program of requirements for the design of the PVT panel. In the second part a new PVT panel is designed. The design phase results in a detailed design of the PVT panel. In the third part, the PVT panel designed is evaluated based on the analyses done. This part also includes conclusions and recommendations for future research. Figure 5 schematically depicts the structure of this thesis.



Figure 4: Reference panel

The analysis starts with a discussion of solar energy systems in chapter 2. Besides to a short description of solar thermal collectors and PV modules, a closer look will be taken at the working principle of PVT, the (potential) market, and the current state of research in this domain. In chapter 3 the potential to use solar energy in the built environment is discussed. In chapter 4 the main actors involved in the decision making process to use solar energy systems will be explored, as well as the demands of these actors. In chapter 5 the results of the analysis are combined to form the program of requirements.

The design phase starts with the generation of ideas in chapter 6. In chapter 7 the ideas are further developed. This results in three concepts which are described in chapter 8. This chapter also describes the decision making process to choose one concept for

further detailing. Chapter 9 describes the detailing of the design, including the construction and components of the panels and the installation process. The final design is presented and evaluated in chapter 10.

This thesis ends with conclusions about the analysis and the design. Recommendations are given for the next steps in the development process of the panels.

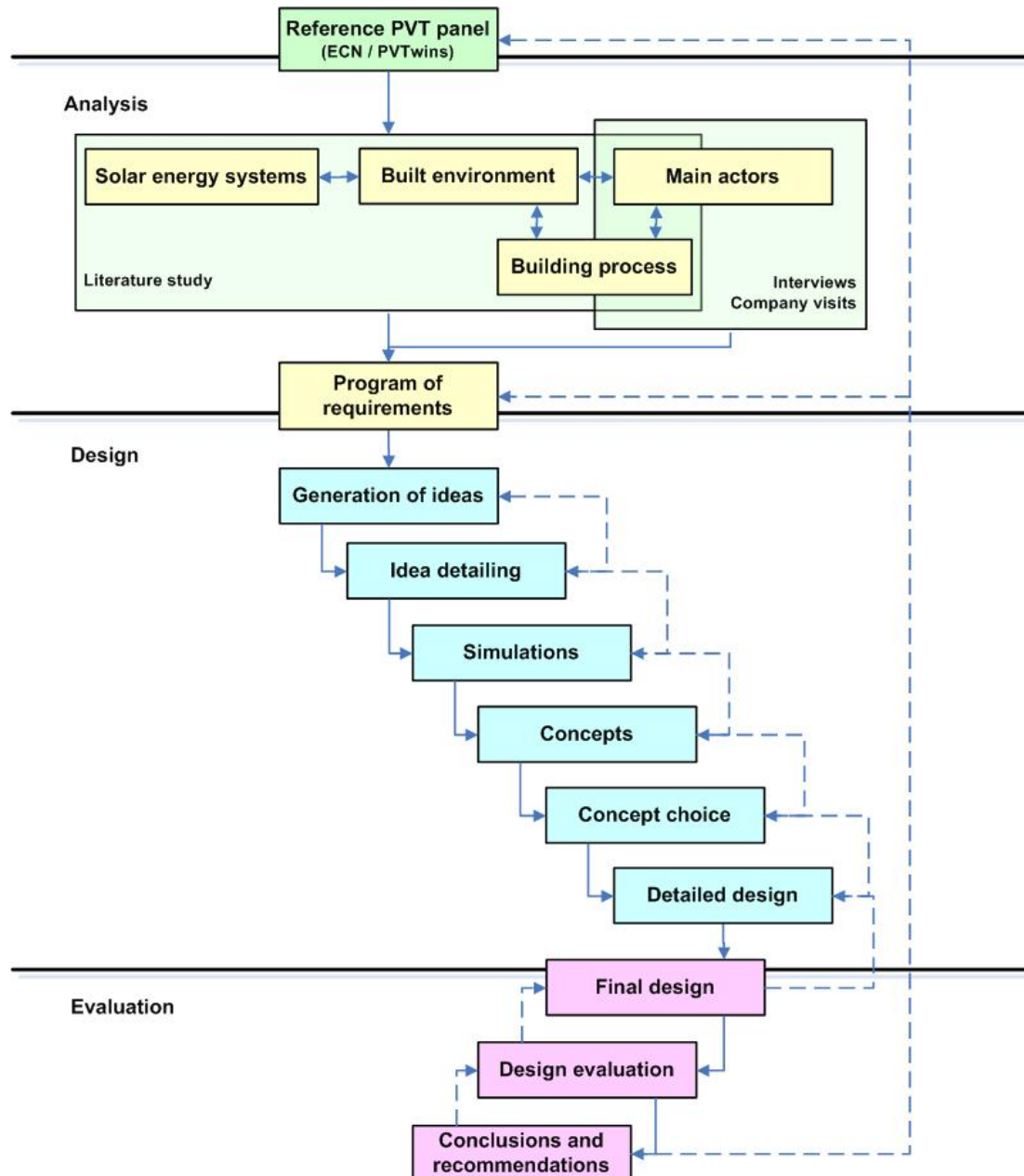

Figure 5: Report structure

Part I: Analysis

“The engineer's first problem in any design situation is to discover what the problem really is.” – Unknown

2. Solar energy systems

This chapter describes the basics of solar energy and solar energy systems. First, some characteristics of solar energy will be given. Then, solar thermal collectors and photovoltaic modules are shortly described, since these systems have large similarities with PVT panels. A more detailed description of solar thermal collectors and PV modules can be found in Appendix A. The next section will give a description of photovoltaic-thermal (PVT) panels. This includes the technology, market, current issues and state of the PVT research, and is meant as an introduction into the field of PVT panels.

2.1. Solar energy

The potential of solar energy is enormous: on average the world receives 1 kW/m^2 , which is worldwide about 2,850 times the total amount of energy needed today. Even though only part of this potential is technically accessible, it is still enough to provide the worldwide energy demand almost six times [3].

In the Netherlands the average yearly irradiation is $1,000 \text{ kWh/m}^2$ [4]. The irradiation varies with the seasons as depicted in Figure 6. This figure also shows a typical seasonal distribution of a building's heat demand for domestic hot water and for space heating. As can be expected, the space heating demand is large in the winter and (almost) zero in summer. The domestic hot water demand on the other hand is quite constant over the year. It must be mentioned that domestic hot water requires temperatures of 60 to 70°C , while space heating works with temperatures between 35 and 50°C .

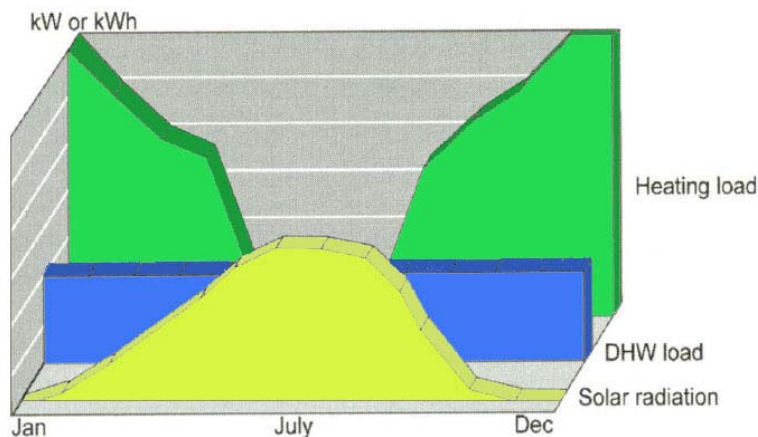

Figure 6: Seasonal variations of heat demand and solar radiation (based on [5])

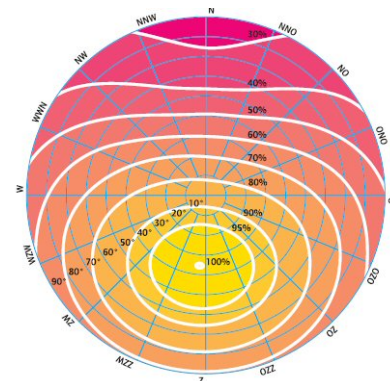

Figure 7: Solar irradiation in the Netherlands [6]

Figure 7 shows the influence of the slope and orientation of a solar panel on the irradiation it receives, as a percentage of the maximum irradiation. As can be seen, the optimal situation arises when a panel is placed under an angle of 36 degrees from the horizontal plane and faced south.

2.2. Solar thermal collectors

Solar thermal collectors are being used to generate heat from sunlight. A thermal collector consists of an absorber and – depending on the type – insulation and/or transparent covers to reduce heat losses. Three different types of collectors can be distinguished: the flat-plate collector, the compound parabolic concentrating (CPC) collector, and the vacuum (tube) collector. A schematic overview of a flat-plate collector is given in Figure 8. For the other collector types, please refer to the appendix.

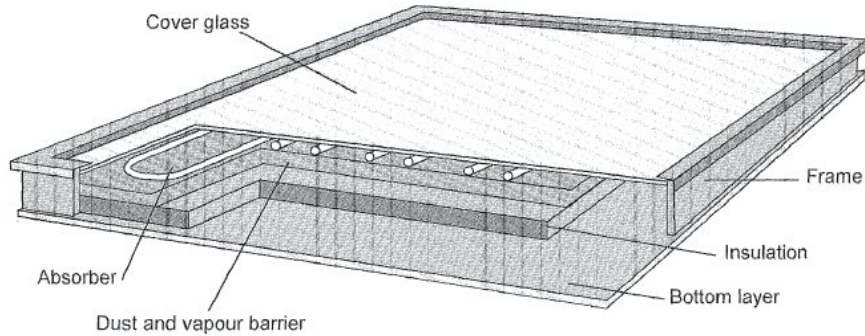

Figure 8: Schematic overview of a flat-plate collector [7]

The working principle of a thermal collector is schematically depicted in Figure 9. Sunlight falls onto the absorber, which functions as a heat exchanger and transports the absorbed heat to the water in the pipes. This heated water is pumped to the storage vessel. A post boiler heater is used to further heat the water (if necessary), after which it is pumped to the hot water tapping point.

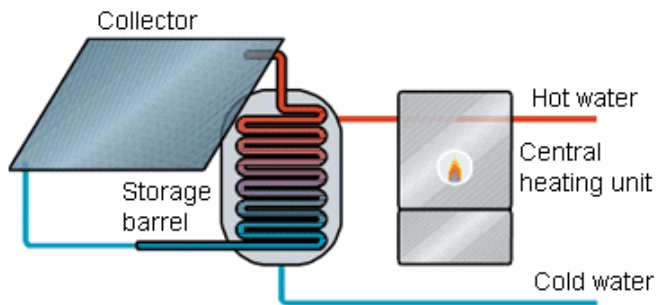

Figure 9: Standard solar thermal system (source material in Dutch) [8]

Solar thermal collectors are often dimensioned to supply 50% of the yearly hot water demand of a household. For an average household, this corresponds to 2.7 m² collector surface and a 100 to 200 litres storage vessel [9]. The average annual saving is about 200 m³ of natural gas and the energy performance coefficient (EPC) of the building is reduced by 0.1 to 0.2 points. A standard solar thermal collector system costs between €1,400 and €1,800 including installation (excluding VAT). The minimum lifetime of a solar thermal collector system is 20 years [8].

The technology behind solar thermal collectors is a mature technology. Thermal collectors comply with the regulations concerning electrical safety, fire prevention, and the quality of drinking water. For an acceptable performance, thermal collectors should be oriented between southeast and southwest, under an angle of 30 to 60 degrees [10].

2.3. Photovoltaic modules

Photovoltaic (PV) modules are used to generate electricity from sunlight. PV modules consist of PV cells encapsulated by glass, EVA, and a rear-side foil. Most solar cells consist of semiconductor materials, like silicon. If a photon from the sunlight is absorbed by this material, an electron can be moved from the ground state to an excited state. This results in an electron-hole pair. An electron-hole pair gets separated by diffusion in the material and an electric field due to the p-n junction. The electrons are collected by the grid contact and reach the back contact via an external load. This process is schematically depicted in Figure 10.

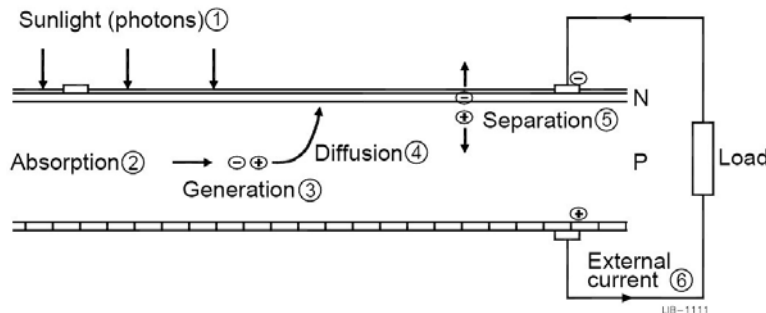

Figure 10: Working principle of a solar cell [11]

PV modules generate direct current (DC). An inverter converts this into alternating current (AC) of 230 V to match the electricity from the grid. Electricity generated by PV modules can directly be used inside the building. If there is more electricity supply than demand, the resulting electricity can be fed into the grid as is shown in Figure 11.

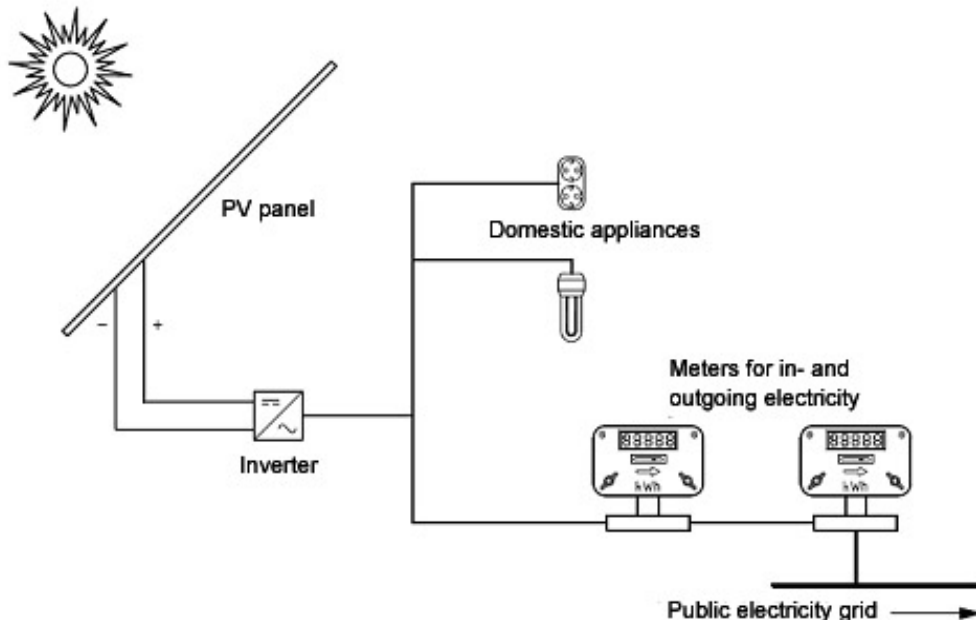

Figure 11: Working principle of a PV module system [12] (source material in Dutch)

A standard PV system of 500 W_p – which is about 4 m^2 – generates approximately 400 kWh of electricity per year under the circumstances in the Netherlands. This is more than 10% of the average electricity demand of a household. The energy performance coefficient (EPC) of a building is reduced by 0.03 to 0.15 points, mainly depending on the type of building [13]. PV systems cost approximately €4.50 to €6.00 per W_p ; this is about

€500 to €750 per m². The prices include the entire system – consisting of the PV module, inverter, cables, and installation frames – but exclude the installation costs and VAT [14]. PV systems have an energy pay back time of less than 3 years. Although PV systems last for a minimum of 25 years, it is financially not yet possible to get back the investment by simply saving energy. Using a lifetime of 15 years, solar energy in the Netherlands costs about €0.55 per kWh, while conventional electricity costs €0.22 per kWh [15]. Subsidies can reduce the kWh price and may therefore help to invest in PV systems. For an acceptable performance PV modules should be oriented between southeast and southwest, under an angle of 20 to 50 degrees from the horizontal plane.

2.4. PVT panels

PVT panels are a combination of PV modules and solar thermal collectors and generate both heat and electricity. This section about PVT panels is based on the PVT Roadmap [2], unless specifically stated otherwise.

2.4.1. Working principle

There are four different types of PVT panels:

- liquid PVT collectors
- air PVT collectors
- ventilated PV with heat recovery
- PVT concentrators.

Within the working principle of each type of PVT panel, the combination of a thermal collector and a PV panel can well be seen. Each type of panel will shortly be described.

Liquid PVT collector

- A liquid PVT collector follows the working principle of a flat-plate solar thermal collector, as can be seen in Figure 12. Solar cells are placed on top of the absorber. The costs of a liquid PVT collector can be approximated by the costs of the flat-plate solar thermal collector plus the costs of the PV cells.

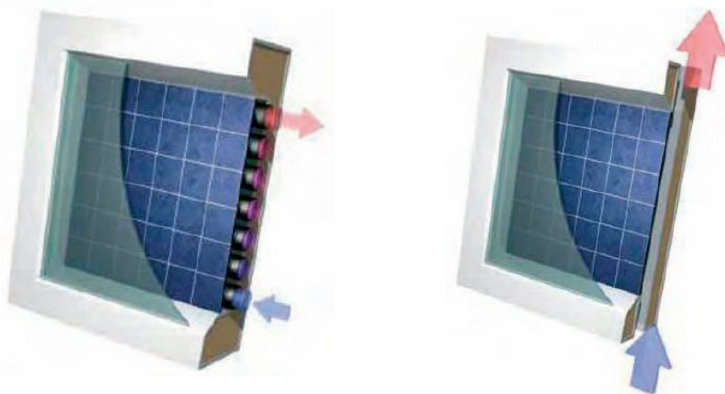

Figure 12: Liquid PVT collector [2] Figure 13: Air PVT collector [2]

Air PVT collector

PVT air collectors look much like liquid PVT collectors, but they use air instead of a liquid as heat transfer medium. Cold air is blown over the back of the absorber to transfer the heat, as is depicted in Figure 13. Tubes at the back of the absorber are not needed for air PVT collectors.

Air PVT collectors have the advantage that regular PV modules can be used, which indicates lower costs compared to liquid PVT collectors. However, the hot air demand of a household is often much lower than the hot water demand, especially during the summer when most solar radiation is available.

Using air instead of water has some large disadvantages. Air has a low heat transfer, due to its low heat capacity and conductivity. Large volumes are needed to transfer the heat,

and the losses through leakage are relatively high. Advantages of using air are that there is no risk of boiling or freezing at the given conditions and leakage does not cause damage.

Ventilated PV with heat recovery

Regular PV modules are often cooled by natural convection through a gap between the module and the roof or façade they are placed on. When this air flow is recovered and used in the building, the PV module functions as a PVT panel, which is shown in Figure 14.

The difference between air PVT collectors and ventilated PV with heat recovery is that the last one is typically designed for one specific building. The PV system is specially designed and produced for each building, which makes it hard to translate the situation to other buildings. Air PVT collectors are designed and build as independent modules, which can later on be placed on or in the roof.

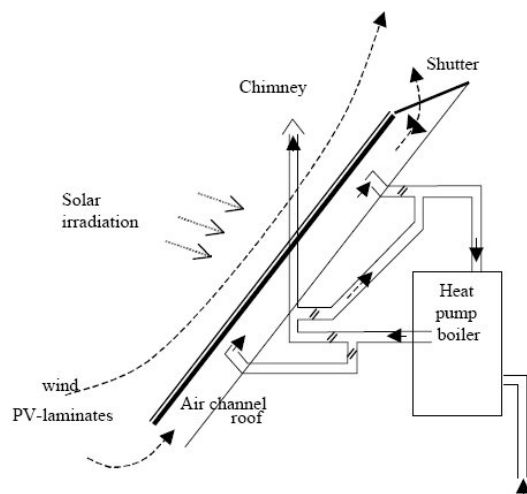

Figure 14: Ventilated PV with heat recovery [16] Figure 15: PVT concentrators [2]

Also ventilated PV panels with heat recovery have the disadvantage of a mismatch between heat supply and demand. It also faces the limitations of air as heat carrier. On the other side, when PV is used for facades, it is replacing the regular facade material. This makes the use of PV facades financially interesting compared to other PV applications, where PV is an addition to the regular building materials.

PVT concentrator

PVT concentrators are based on PV concentrators. Sunlight is concentrated by mirrors, so less PV cells are needed and costs can be reduced. Due to the concentrated sunlight, the PV cells may become very hot and need to be cooled. If this is done actively, we speak of a PVT concentrator. PVT concentrators are mainly suited for places with high percentages of direct irradiation, which excludes the Netherlands.

PVT concentrators are quite thick, which makes them unsuitable for non-flat roofs. Efficiencies can be largely increased by sunlight tracking, but this also increases the maintenance costs. Figure 15 shows and how PVT concentrators can be placed on a flat roof. Due to their large volumes, it is difficult to integrate them into a sloped roof.

Glazing

To reduce thermal losses, all types of PVT panels may be covered by one or more layers of glass. PVT panels that have a glass cover are called “glazed” and have smaller thermal losses and therefore higher thermal yields. However, glazed PVT panels also have higher reflection losses and get warmer. This has a negative effect on the electrical performance, since PV cells have a lower yield at higher temperatures. Besides, high

temperatures may cause delamination of the PV encapsulant and overheating of bypass diodes. When deciding between glazed and unglazed collectors, a compromise has to be found between thermal and electrical yield and degradation of the materials.

Performance

At the moment there is no standard that prescribes how to determine the performance of a PVT panel. Since the thermal and electrical performances are related, it is difficult to set a good standard to compare the overall performance of PVT panels. Within this thesis, the electrical and thermal performances will be evaluated separately.

The performance of a PVT panel depends on the irradiation and therefore on the weather, location, and orientation. Taking a 4.1 m² liquid PVT panel of PVTwins as a reference, the yearly saving in the Netherlands is 410 kWh of electricity¹ and 230 m³ of natural gas. This is about 50% of an average households warm water demand and 12% of its electricity demand [17].

2.4.2. PVT market

Since PVT panels are a combination of PV modules and solar thermal collectors, it can be expected that the main market will be the segments both PV modules and solar thermal collectors are being used. The residential sector is with 90% by far the largest market segment for solar thermal collectors. Domestic hot water (DHW) applications are responsible for almost 90% of the demand in this sector. Looking at the PV market it turns out that the main sector exists of grid connected distributed systems. A large proportion of this sector consists of residential systems. The residential sector will therefore be the target sector within this thesis.

Competitors

The main competitor for PVT will be side-by-side PV modules and solar thermal collectors. These products have the advantage of already being on the market for some time, while PVT is just entering the market. Because of a larger market share, PV and thermal systems will have lower production costs. It is expected that the use of side-by-side PV and solar thermal systems will increase, leading to combined installation processes.

Depending on the view, different other competitors can be distinguished. Looking at the energy performance of a building, many other technologies – like better insulation and heat recovery units – may be alternatives for solar energy. Besides, there are other options for the simultaneous generation of heat and electricity, like a heat pump combined with PV or HRe boilers.

Actors

The PVT Roadmap has classified the involved actors into three categories: suppliers, influencers, and decision makers. Following this division, the actors are presented in Table 1. In chapter 4 the actors the actors influencing the design of the PVT panel will be discussed in more detail.

¹ If the electrical performance of the PVT panel is compared to the performance of the PV modules on page 17, it looks like the PVT panel has a higher yield, while PVT panels are expected to perform less given the same conditions. The difference can be explained by the conversions factors used by the different sources. For the PV module, a conversion factor from W_p to kWh of 0.75 is used, while for the PVT panel this factor is 1.0. If the same conversion factors were used, the PV module would have a higher electrical yield than the PVT panel.

Table 1: PVT actors [2]

Suppliers	Influencers	Decision makers
	Installation company	Energy company
Building element supplier	Municipality	
PV manufacturer	Architect	Farmer
PVT assembler	Energy consultancy and engineering company	Owners of public pools, sport facilities, hotels and campgrounds
Solar thermal manufacturer	Consumer organisation	Industry
	Financial sector	Hospitals and homes for the elderly
	National government	Home owners
		Real estate company
		Real estate developer
		Housing association

2.4.3. PVT research

A lot of research about PVT panels has been done. The research has mainly focussed on technical issue like improving efficiencies. This section shortly describes the current state of PVT research in the Netherlands and is based on personal communications with Herbert Zondag (12 June 2006).

The first PV-Thermal panels origin from the 1970's, when the oil crises hit the world. The Dutch PVT research starts at TNO (Dutch Organisation for Applied Scientific Research) in 1989 with a focus on uncovered PVT panels for heat pump applications. In 1998, Douwe de Vries gets his doctoral degree for his research entitled 'Design of a photovoltaic/thermal combi-panel' at Eindhoven Technical University (TU/e) [18]. A first prototype of a flat plate collector is built within the framework of his research.

In 1999 PVT research enters ECN, where research is done on module design and systems. A second prototype for an uncovered flat plate collector is developed and tested. The main driver is to increase the thermal efficiency. For the third prototype, improved manufacturability is the main driver. The prototype is developed by ECN, Shell Solar, and ZEN Solar and in 2003 these PVT panels are placed on the new head office complex of Renewable Energy Services (RES) in the United Kingdom.

Under the EU project PV-Catapult – coordinated by ECN – the PVT Roadmap [2] and a guideline for PVT performance testing [19] are developed. After 2005, PVT research at ECN is limited due to financial reasons. However, ECN is still involved in the Task 35 'PV/Thermal Solar Systems' of the IEA Solar Heating and Cooling Programme. This task has the objective to "catalyse the development and market introduction of high quality and commercial competitive PV/Thermal Solar Systems and to increase general understanding and contribute to internationally accepted standards on performance, testing, monitoring and commercial characteristics of PV/Thermal Solar Systems in the building sector" [20].

Through research and demonstration projects several key issues have been identified that should receive attention for a successful market introduction of PVT. Figure 16 shows a schematic overview of these PVT key issues. The issues that will be focussed on within this thesis are highlighted.

A study by Zondag [21] gives an state-of-the-art overview of realised PVT demonstration projects worldwide. Within this study seventy PVT installations are described, consisting of 39 PVT air collectors, 15 PVT liquid collectors, and 16 collectors combining liquid and air. Also the lessons learned from these projects are described.

2.5. Conclusions for design

Looking at the heat demand and the solar radiation in Figure 6, it can be seen that there is a large mismatch with space heating. The match between domestic hot water and solar radiation is better. The demand for space heating can be lowered by better insulation or heat recovery ventilation, but the mismatch will remain. Considering the matching of supply and demand and the heat exchanging properties of air and water, it is decided to focus the design on liquid PVT panels.

At the moment five manufacturers of liquid PVT panels are known. These manufacturers and the properties of their panels are shortly listed in Table 2, to give insight in the currently available panels and their performances.

Table 2: Liquid PVT panel manufacturers

Manufacturer	Thermal performance	Electrical performance	Price indication	(Demonstration) projects
PVTwins (ZEN Renewables) <i>The Netherlands</i> [23;24]	333 kWh/(m ² ·yr)	117 W _p /m ²	€870,-/m ²	<ul style="list-style-type: none"> - 45 m² on the Renewable Energy Service building in the United Kingdom - 3 unglazed panels on a low energy building in Kollum – the Netherlands - 27 m² on a governmental building in Zoetermeer – the Netherlands - 154 single-family buildings in Alkmaar with each 2.75 m² of PVT
Millennium Electric T.O.U. Ltd. <i>Israel</i> [24]	30% (water) 30% (air)	14%	\$850,-/m ²	<ul style="list-style-type: none"> - Eleven demonstration projects of different sizes, latest dated from 2001
Solarhybrid <i>Germany</i> [25]	unknown	143 W _p /m ²	unknown	<ul style="list-style-type: none"> - Seven installations of different sizes on single and multi family buildings
Holtkamp Solar Energy Systems Gmbh <i>Germany</i> [26]	unknown	unknown	unknown	
Solar Zentrum Allgäu <i>Germany</i> [27]	500 W/m ²	120 W _p /m ²	unknown	<ul style="list-style-type: none"> - Test series at Solar Zentrum Allgäu

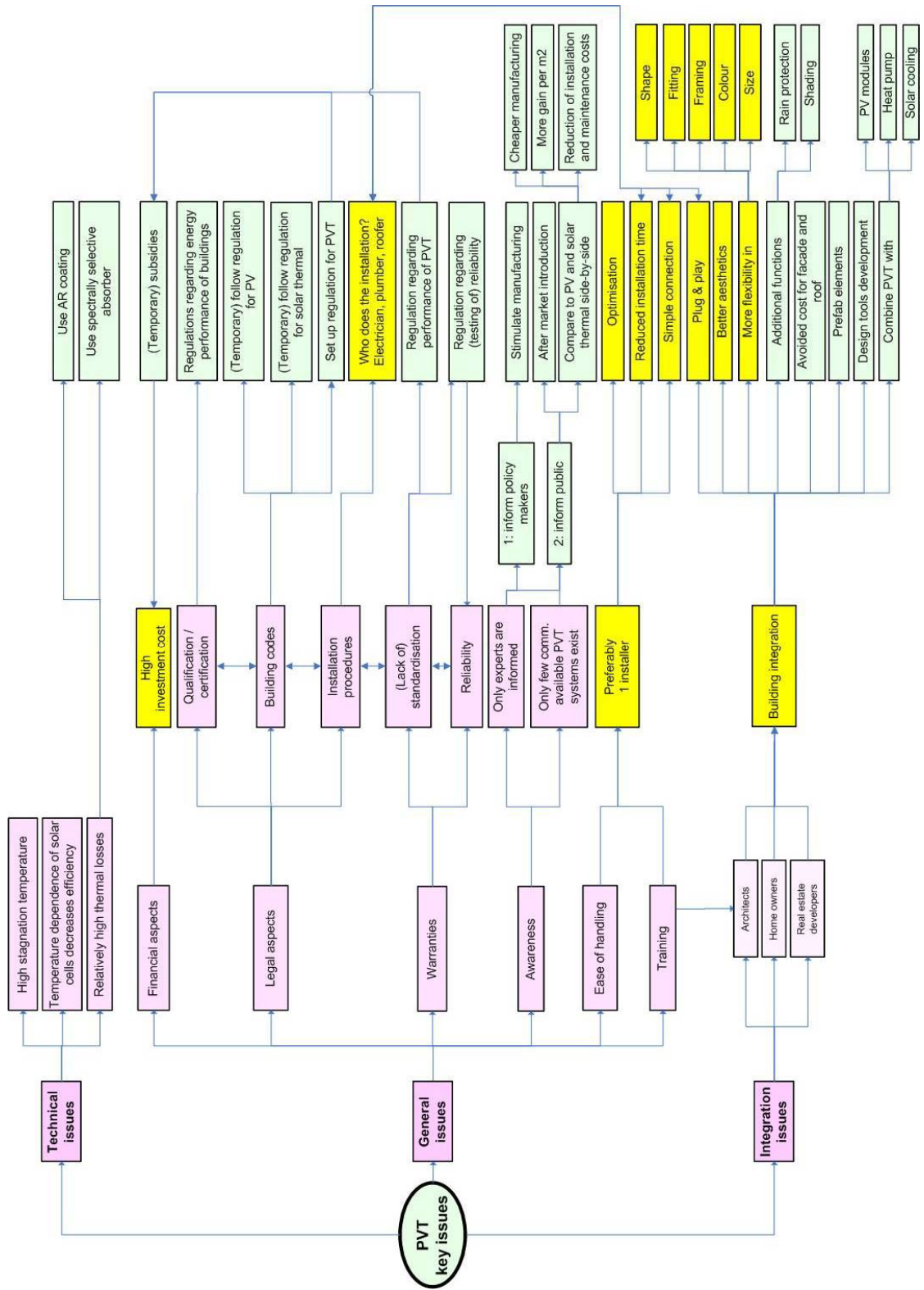

Figure 16: Overview PVT key issues

3. Built environment

The Dutch built environment uses 1,000 PJ per year and is therefore responsible for 35% of the national energy demand [10]. For an average Dutch household of 2.3 persons, this means an energy use of 3,402 kWh electricity and 1,652 m³ natural gas [28]. Large steps towards a sustainable energy supply can therefore be made in this sector.

This chapter describes some basic characteristics of the built environment considering the use of solar energy. First, the composition of the Dutch housing stock will be described, followed by the potential for solar energy. Furthermore, the composition of a sloped roof will be explained, after which some examples will illustrate how solar panels can be placed on the roof.

3.1. Housing stock

The built environment can be divided into residential and utility buildings. This thesis focuses on the residential sector, which in the Netherlands consists of 7.0 million houses [29]. About 56% of all houses are owner occupied, the other 44% are rental houses [30].

Table 3: Changes in the residential house stock in 2007 [29;31]

Changes in house stock	# houses
Newly built houses	80,000
Demolished houses	20,000
Retrofitted houses	150,000
Large maintenance	300,000
Replacement heating unit	450,000

Each year, more than 900,000 houses are– among others – adapted to a more efficient use of energy. The distribution of the adaptations is given in Table 3. The existing housing stock offers good opportunities for energy saving technologies, especially during ‘natural’ change moments like move, alteration, or retrofit [31].

For flat roofs, the orientation of the building is not important for the use of solar systems. Solar panels will be placed on a separate construction and can easily be directed towards the sun. For sloped roofs, the orientation and slope are fixed, which often leads to a non-optimal situation. In general a minimum irradiance of 80% of the optimal situation is considered acceptable, which in practice means an orientation between southeast and southwest and a roof angle between 20 and 50 degrees (see also Figure 7 on page15).

In the Netherlands about one third of the houses are apartments with flat roofs. The other two third consists of sloped roof houses [32]. Around 75% of these sloped roof houses have a roof area orientated between southeast and southwest. Shadowing and obstacles like skylights reduce the technical potential by about 30%, which means that more than 50% of all sloped roof could be used for solar panels [33].

Taking 80% of solar irradiation as a minimum, about 127 km² of Dutch roofs are suitable for solar systems [34].

Following equations 1 and 2, this gives a potential of about 19 TWh/yr for electricity and 38 TWh/yr for thermal energy. Although this is an enormous amount of energy, together it is less than 1% of the total energy demand in the built environment.

$$\text{PV potential} = \text{available area} \cdot \text{solar irradiance} \cdot \text{PV efficiency} = 127 \cdot 10^6 [\text{m}^2] \cdot 1,000 [\text{kWh/m}^2/\text{yr}] \cdot 0.15 \quad (1)$$

$$\text{Thermal potential} = \text{available area} \cdot \text{solar irradiance} \cdot \text{thermal efficiency} = 127 \cdot 10^6 [\text{m}^2] \cdot 1,000 [\text{kWh/m}^2/\text{yr}] \cdot 0.30 \quad (2)$$

Solar thermal collectors are often dimensioned to supply 50% of a household's warm water demand, since domestic hot water demand and supply do not match during the year and there are no good solutions for seasonal heat storage (yet). For an average household this means a collector of 2.7 m² is needed to reduce the hot water demand by 50%.

PV panels can be dimensioned to supply 100% of yearly electricity demand, since an overcapacity in summer can be supplied to the grid, while in winter a shortage can be demanded from the grid. Using equation 3, an annual module efficiency of 15% causes a need of about 23 m² of PV panels to meet the yearly electricity demand. If this is compared to the 2.7 m² needed for the thermal energy, it may be advisable if PVT panels can be combined with PV modules to match the energy demand.

$$\text{Area needed} = \text{yearly demand} / (\text{yearly irradiation} \cdot \text{efficiency}) = 3402 \text{ [kWh/yr]} / (1,000 \text{ [kWh/m}^2\text{/yr]} \cdot 0.15) \quad (3)$$

3.2. Roof construction

The main function of a roof is to protect the building from environmental influences like wind, rain, and sun. In this thesis only sloped roofs are considered. Solar panels on sloped roofs are better visible for consumers, which is needed for increasing acquaintance and public acceptance of these systems.

Figure 17 shows the cross-section of a sloped roof and Figure 18 illustrates the placement of the roof tiles. The lower construction is covered by a thermal insulation and a vapour delaying foil, which prevents condensation of water under the roof. Vertically placed on this construction are the battens; the tile laths are placed horizontally.

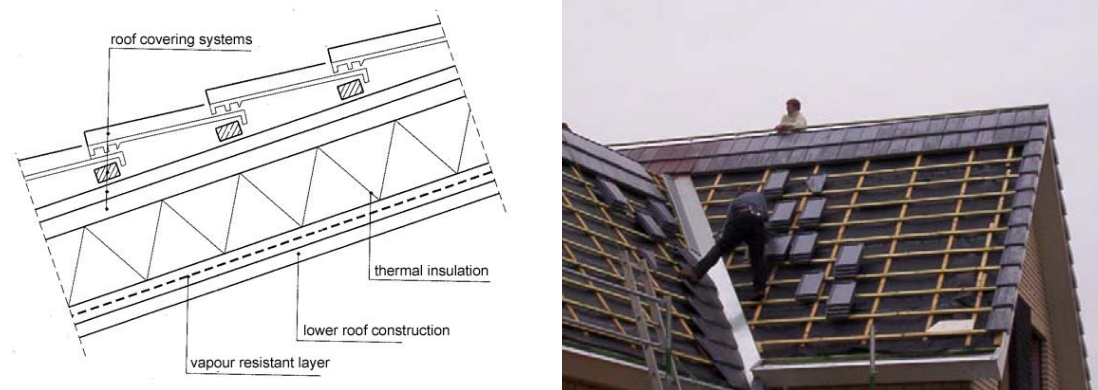

Figure 17: Cross-section of a sloped roof (source material in Dutch) [35] Figure 18: Placing roof tiles on a sloped roof

Roof tiles do not have standardised dimensions. A view at the five models of profiled roof tiles of manufacturer Monier [36] – see Table 4 – shows that length, width, as well as working width differ significantly. Furthermore, each roof tile has a margin of -10 to +10 mm due to flexibility in the amount of overlapping. The distance between the battens and tile laths depends on the type of roof tiles that will be used. At the moment mainly 'Sneldek' roof tiles are being used.

Table 4: Roof tiles dimensions in mm [36]

Model	Length	Width	Working width
Sneldek	420	332	300
Neroma	420	332	300
Utrecht	380	230	200
VH 285/302	361	256	218
OVH 200	371	263	200

3.3. Building integrated solar panels

Solar panels can be mounted on the roof or integrated in the roof. Some examples of installation possibilities will be shown. Figure 19 shows the universal installation system VarioSole of Renusol (formerly Ubbink Solar) [37]. The system can be used for all kinds of PV modules. The system is placed on an existing roof, so only a few roof tiles need to be moved in order to fasten the hooks to the tile laths. The hooks hold horizontal metal slats, which hold special clips to connect the PV modules.



Figure 19: On roof installation – VarioSole system [37]

Figure 20 shows Renusol's InterSole installation system. This system is roof integrated, which means all roof tiles at the place of the solar panels have to be removed and a special plastic sub-layer is used to keep the roof watertight. This installation system is also capable of connecting different kinds of PV modules. Metal slats are fastened horizontally or vertically onto the plastic sub-layer. Also within this system, special clips on the slats are used to connect the PV modules.

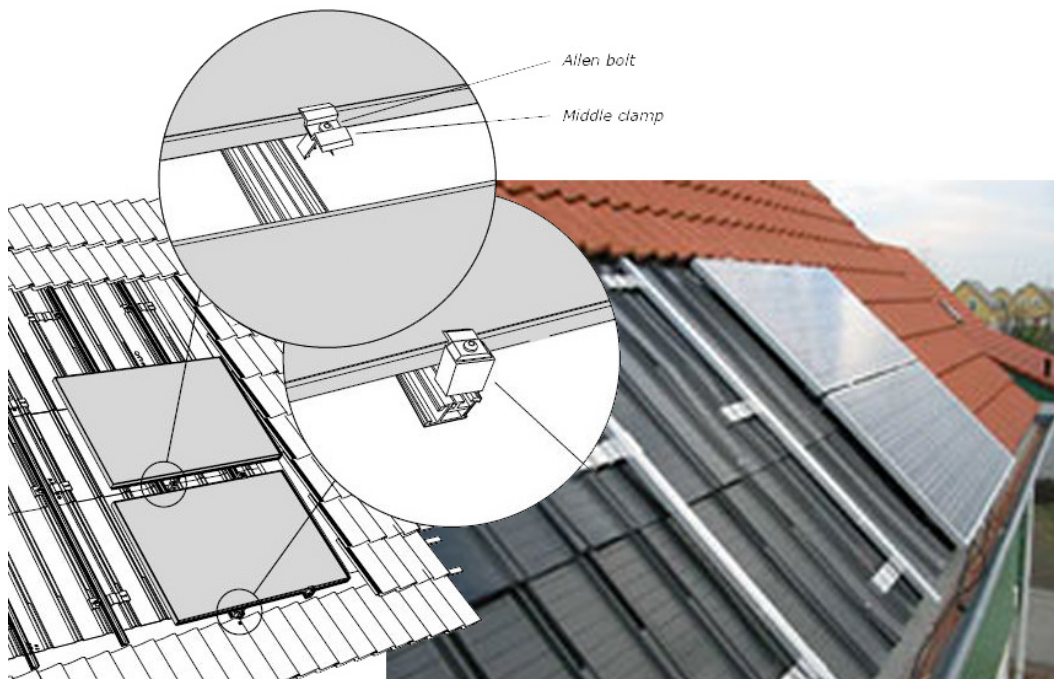

Figure 20: In roof installation – InterSole [38]

Figure 21 shows Itho's solar thermal collector system, which is roof integrated. After removal of some roof tiles, a roof integration layer is placed to keep the roof waterproof. The pipes go through the roof at position C. This system is only suitable for this specific collector.

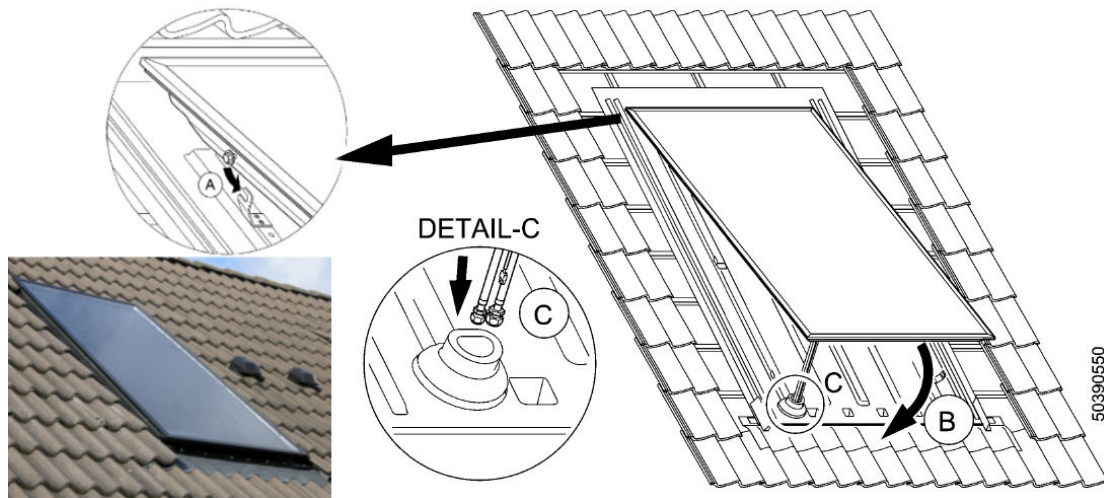

Figure 21: In roof installation – Itho [39]

3.4. Conclusions for design

Based in the analysis of the built environment, it is decided to design the PVT panel for sloped roofs in the residential building sector, since this appears to be a large and accessible market segment. Flat roofs are also an interesting sector, but the opportunities for building integration are limited. Beside flat roofs often need to be strengthened before solar panels can be placed, which is fewer the case for sloped roofs.

The panels will primarily be designed for large building projects, both for new construction and retrofit. Within large building projects scaffolds and cranes can be used without (much) extra costs. Besides, installation times will probably be shorter, since installers have time to get to know the specific tricks to install the panels easily on the roofs. The influence of this decision on the actors involved will be discussed in the next chapter.

Looking at the energy demand of a household and the ratio between thermal and electrical supply of PVT panels, it is recommended to make it possible to combine PVT panels with PV modules. Therefore, the PVT panel design must be easily adaptable to a design for PV modules in the same product family.

4. Actor analysis

The actors involved in the field of PVT have been summed up in Table 1. This chapter will have a closer look at the actors involved in the building process and at the building process itself. The main actors that are influencing and being influenced by the PVT panels are identified and their demands are listed.

4.1. Building process

The building process globally consists of five phases: planning, designing, tendering, selling, and building. Figure 22 schematically depicts the building process for large projects – both new construction and retrofit – and the actors involved. After the completion of the buildings, the usage phase begins.

The planning phase involves the start-up of the building project. A taskmaster – e.g. a real estate developer, housing association, or municipality – decides to develop a building project. Possibly encouraged by subsidies or restricted by legal aspects the taskmaster can decide to use solar energy.

Both retrofit and new construction projects have to comply with (national) legislation. Looking at Dutch building regulations, the *Bouwbesluit* includes – among others – building regulations for energy use of buildings, like the energy performance coefficient (EPC). The local *Welstandcommissie* can set demands considering the charisma of the houses to ensure they fit within the environment.

Together with an architect and possibly the (future) occupants of the houses, the taskmaster makes an inventory of the building requirements. This program of requirements serves as a starting point for the architect to start the design phase.

In the design phase the architect starts making a sketch design based on the program of requirements. If solar energy is not included in the demands, the architect can suggest the option to the taskmaster. The taskmaster can give feedback on the sketch design, after which it is further drawn up. The architect now gets advice from a constructor, installation advisor, and possibly other specialists. These specialists give advice about the design of the houses and perform calculations, for example about the rigidity. This leads to a temporary design. After more reviewing and adaptations, the architect can present the final design and its specifications.

In very large building projects – where the process is more complex – constructors and advisors are often consulted from the beginning of the design process.

With the design specifications in mind a contractor is hired to direct the building phase (tender phase). The contractor may be the same as the taskmaster, for example a real estate developer. Once the price of the building process is known, the promotion and selling of the buildings can start.

The building phase consists of the physical building of the houses. The contractor surveys the building process, the different people working on the building site, and the costs. Different specialists can be hired – like roofers, electricians, and plumbers – to build the roof and connect the installations.

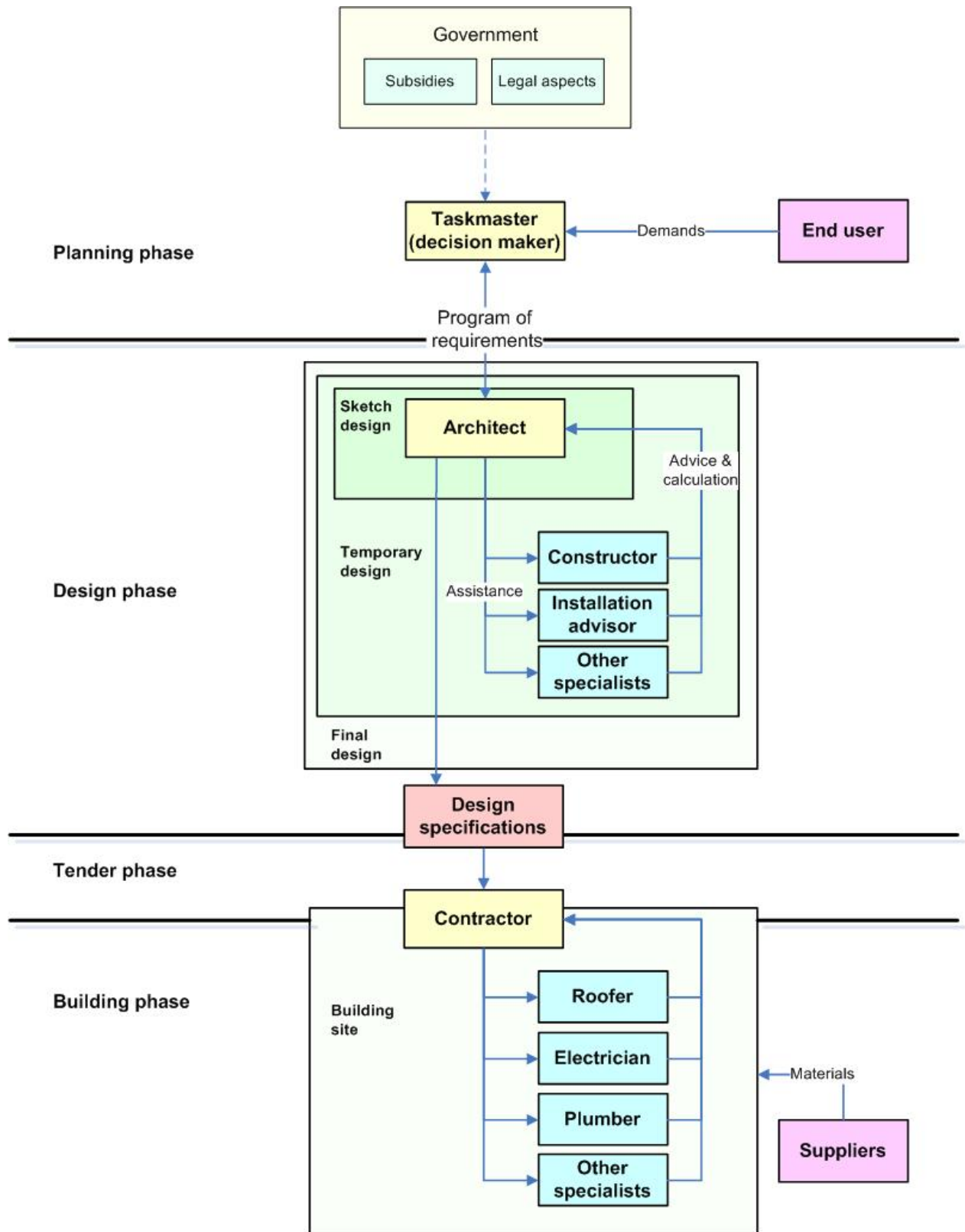

Figure 22: Schematic overview of the building process and actors involved

4.2. Main actors

The main actors involved in the decision making process to use solar energy systems are the taskmasters, architect, and installers. Especially within large building projects the demands and wishes of the (future) occupants may have no or only little influence on the design of the buildings. However, the wishes of the occupants should not be underestimated, since they experience the effects of the solar panels on their roofs for the longest time. Occupants experience the profits of solar panels, like more comfort and lower energy bills, but also the troubles, like maintenance or possible leakages. Besides this, the presence of solar panels may influence the value of their house and the pleasure of living in a certain house or quarter.

The choice of the taskmaster to use solar panels will mainly be influenced by profitability. Although they may be positively influenced by a good design, other factors – like subsidies – will have much more impact on the choice for a solar energy system. The different kinds of taskmasters will therefore not be considered as main actor.

Architects will mainly focus on the aesthetical value of the panels. Besides they need to comply with the energy performance requirements of the houses. It is therefore important to know what architects think about the use of solar energy. Installation companies give advice about the choice between different energy systems and should therefore be familiar with PVT panels. Besides, installers need to install the panels. If the installation is simple, installers will probably be more enthusiastic about the PVT system and recommend it more often.

The wishes and demands of the main actors will be described in the next sections. The information is collected from company visits, interviews, and reports.

4.2.1. Installation companies

A good installation of the PVT panels is needed for a proper functioning of the system and to keep the roof watertight. To find out how PVT panels are installed, a retrofit project in Alkmaar – the Netherlands is visited. Within this retrofit project, PVT panels are placed on the roofs of row houses. To compare the PVT installation with the installation of thermal collectors, also a solar system installation company is visited. This company installs thermal collectors and PV modules for private persons. It turns out that the installation processes of PV modules, thermal collectors, and PVT panels are comparable. A complete record of the visits can be found in Appendix B and Appendix C.

Installations are performed by a plumber. The removal and (re)placement of the roof tiles is preferably done by a roofer. Installation times for single systems take about 8 to 10 man-hours, including preparation activities like removing roof tiles and safety precautions. The in-house connecting of the system to the heating system takes another four man-hours.

Installers experience no real problems with thermal collectors. They only indicate that the weight of the collector – about 70 kg – should be reduced. It may be helpful if the lower side of the collector could be supported by a tile lath, before the collector is placed to its final position. The changeover between the panels and the roof tiles is realised by a flashing set, which is depicted in Figure 23. A problem that is not indicated by the installers is the sawing of roof tiles to fit closely to the panel.



Figure 23: PVT flashing set

Although familiar with PVT technology, the installers have their questions about its functioning. Combined systems – like PVT panels – have a higher chance of failure and

the heat requirement for PV and thermal collectors are contradictorily. However, they do think PVT will be a good option for newly built housing projects. In these projects the installation costs will be relatively low due to the availability of scaffolds and cranes. The installers also mention that occupants should get feedback about the functioning of the system. The risk of long term non-functional systems will be reduced by a regular look at the feedback system by the occupants.

It is difficult to determine the costs for installation, since these depend on many factors: the number of panels to install, condition of the roof, accessibility of the roof, etc. Besseling B.V., the installation company of the retrofit project in Alkmaar, charges €450,- for the installation of three PV modules of about 1.3 m², under ideal circumstances. The installation costs of thermal panels are higher, between €500,- and €1,000,- for around 3 to 4 m². To summarise, installation costs will be about 20% of the costs for the PVT panels.

4.2.2. Architects

To get insight into the wishes and demands of architects regarding solar systems, an inventory research is set up. Via the professional association BNA (Bond van Nederlandse Architecten – Royal Institute of Dutch Architects) architects are asked to participate. Six architects with and without experience regarding solar energy systems responded and are interviewed telephonically. The questionnaire used for these interviews can be found in Appendix D. The results are supplemented with six interviews with architects by Jadranka Cace of Horisun, which are done within the framework of the European PV UP-SCALE project in 2007. Considering the outcomes and the goal of the research – inventory of wishes and demands – it was decided not to interview more architects.

The outcomes are compared and combined with earlier research done within IEA Task 7 [40], a conversation with Henk Kaan (architect at ECN), and a workshop concerning the design and architectural application of solar thermal collectors [41]. The conclusions are listed below.

Architects are quite satisfied with the current solar panels: if it is clear from the beginning of the project that solar panels will be used, the building design can sufficiently be adapted to the panels. The main restrictions experienced by architects are the costs and the restricted choice of dimensions. Besides, the required roof angle and orientation can limit the design freedom.



Figure 24: Traditional building style for retrofit (left) and new construction (right)

It is important that solar panels fit in the environment and join the building style that is used. This may be difficult when the taskmaster asks for a traditional building style, of which Figure 24 shows two examples, since solar panels often have a high-tech appearance. The panel and its functioning may be visible, if the finishing is neat. The finishing mainly concerns the borders, which should form a smooth transition to another

material or a connecting solar panel. Flexible dimensions are very important for the integration of solar panels and may possibly be achieved through flexibility in the borders between the panels. Also a design with simple, strict patterns is mentioned as desirable charisma. The standard blue colour of solar panels is acceptable for most architects. However, it would be appreciated if there were several colours to choose from for the panels and the borders. Anthracite/charcoal-grey is by far the most favourite colour.

Some architects question the economical feasibility of solar panels: often there are other, cheaper solutions to save or generate energy. Architects who are not familiar (yet) with solar energy systems are mainly unknown with the possibilities concerning positioning, dimensions, and finishing. It is stated that solar panels may not hinder the entrance of daylight in the building. Shading devices with solar technology are often mentioned as interesting option for solar panels.

4.2.3. Occupants

What do occupants think of the application of PV in their houses? In 2005, Kets et al. [42] did research in the PV districts Vroonermeer (Alkmaar) and in the City of the Sun (Heerhugowaard – the Netherlands) to get insight into this topic. Both occupants and potential buyers of houses equipped with PV were interviewed.

For most people PV has a neutral or positive effect on the appreciation of the district. The production of green electricity and the lower energy bill are given as main reasons. Main reasons for a low appreciation are a decreased living experience (e.g. impossibilities for the placement of a dormer) and technical problems. A lack of information can negatively influence the appreciation of the PV panels. However, for 80% of the occupants interviewed, the application of PV has not played a role in the decision to buy or rent the house. A pay back time of about 4 years is acceptable for most homeowners, while tenants do not want to pay more each year for a PV system than it brings in. Within the investigated projects, pay back times for the occupants are set at 10 years. The remainder of the investment needed to buy the PV systems is subsidised by the European Commission.

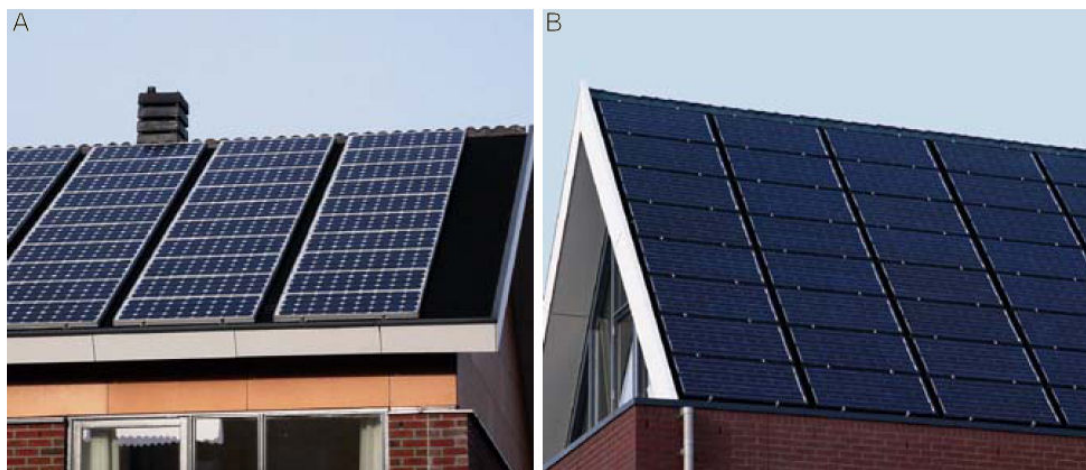

Figure 25: Blue PV panels (A) and dark PV panels (B) [42]

Looking at the aesthetical value of the PV panels, full roof systems where the PV panels are placed parallel to the roof – see Figure 25 – are appreciated best. Furthermore 65% of the occupants prefers the dark panels (B) above the blue panels (A). The blue panels are preferred by 21%. It is remarkable that occupants tend to have a preference for the panels placed on their own roof. Potential buyers, taskmasters, estate agents, and architects also prefer the dark PV panels. These panels are appreciated better because of the better integration in the design, less outstanding PV cells, and the nice and calm impression of the roof.

In addition to the research of Kets et al. a small informal research has done during the term of this thesis. Based on a set of pictures – of which some are depicted in Figure 26 – different people were asked what they liked best for the panels: horizontal lines, vertical lines, or a combination of both. Nobody liked the combination of both, but the opinions about horizontal or vertical lines were divided. Some people say that horizontal lines join the line of the building better, while others mention that vertical lines have the advantage that the panels also looks nice if the neighbour does not have solar panels. To give in to as many wishes as possible, it seems wise to design panels that can be placed both to make horizontal and vertical lines.



Figure 26: Possibilities to position a number of panels on a roof

4.3. Conclusions for design

The main actors to take into account within the design process are the installers, architects, and occupants of the houses. Installers say they do not experience any problems, but in practice it can be seen that the large weight and the panel's shape make it difficult to position the panel at the right place. Besides, roofers have to saw the roof tiles to fit near the panels, which is undesirable.

Architects experience the costs and fixed dimensions of the panels as main restrictions of solar panels. It is advisable to investigate the possibilities for flexible dimensions. The finishing of the panels should be neat, and charcoal-grey is the favourite colour to use. It is also important that the panels match the charisma of the house and its environment. The current high-tech appearance of solar panels does often not comply with the required traditional building style. Finally it is advisable to design panels that can be connected both horizontally as vertically.

The influence of solar panels on the decision to buy or rent is house is negligible. Besides, occupants are hardly prepared to pay extra for solar panels. It turns out that occupants do not have to be considered a main actor for solar panels. It is however taken into account that full roof systems in dark colours are preferred by occupants and potential buyers.

5. Program of requirements

This chapter describes the requirements for the design of a new PVT panel. Within this design, special attention will be paid to user requirements, building integration, roof installation, costs, and manufacturability. The requirements given in this chapter follow from the analyses of the previous chapters.

Although only the PVT *panel* will be designed, some requirements are set for the broader PVT *system*, as defined in section 1.2. Because of this, it is prevented that the PVT system will not be able to meet its requirements, due to choices made for the panel design.

5.1. Primary functioning

1. The waterproof functioning of the roof must be preserved.
2. The system must provide hot water and electricity. The thermal and electrical yield are inversely related. Based on currently available market products, the requirements are set as follows:
 - a. Electrical output of 90 kWh/(m² yr)
 - b. Thermal output of 1.0 GJ/(m² yr) = 300 kWh/(m² yr)
 - c. Collector price of € 750,-/m².

5.2. Context

3. The system will be designed for use in the Netherlands from 2020.
 - a. The process of prototyping, testing and certifying must be able to be started from 2009.
 - b. Technologies and processes that will be used must be (commercially) available in 2009.
4. The system must be suitable for integration in roofing tile roofs with a tilting angle between 20 and 60 degrees from the horizontal plane.
5. The system must be suitable within large residential building projects, both new construction and retrofit.
 - a. Added value is realised if the system is also usable for:
 - i. Placement on top of existing roofs (not roof-integrated)
 - ii. Flat roofs
 - iii. Utility buildings.
6. The system must be suitable for both small and large systems within the roof, ranging from a single solar panel to multiple panels in width and height.
 - a. Added value is realised if the system:
 - i. Can be used for complete solar roofs
 - ii. Has flexible dimensions.
7. The PVT panels must be able to be combined with PV panels.

5.3. Legislation and safety

8. The building – including the PVT system – must comply with the Dutch building code (Bouwbesluit [44]), which contains regulations for the construction of new and retrofit buildings with regard to safety, health, usability, energy efficiency, and environment.
9. According to the NVN7250 norm (Solar energy systems – Integration in roofs and facades – Building aspects) [12], the system must withstand Dutch weather conditions, including wind, rain, snow, hail, and frost.
 - a. The system must resist corrosion of (metal) parts during its life time.
 - b. The system must resist material break down due to UV radiation, for at least the life time of the system.

10. The system must be fireproof according to the NVN7250 norm.
11. The system must function with ambient temperatures between -25°C [12] and 50°C.
 - a. The system must withstand fast temperature changes and the corresponding thermal expansions of materials.
12. The system must be safe to install, operate, and maintain.
13. The system must be protected against damage by animals.
 - a. Animals are not able to gnaw at the cables.
 - b. Birds are not able to build their nests under or next to the system.
 - c. Bugs are not allowed to enter the system or the house via the system's connections.

5.4. Building integration

14. The panel must fit in its environment and be consistent with the style of building that is used.
 - a. The charisma of the panel must be consistent with a traditional building style of which Figure 24 showed an example.
15. The finishing of the panel must be good, especially the borders of the panel.
 - a. There must be a smooth changeover between the panel and other building materials or panels.
 - b. Preferably there are different options to choose from concerning
 - i. Dimensions
 - ii. Borders
 - iii. Colours; charcoal-grey is a preferred colour.
16. The system can be used in combination with skylights and dormers, which may be placed at the same time or at a later moment.
17. The panel may not hinder its environment by reflecting fluids, vapours or other material flows to its environment.

5.5. Installation

18. The installation of the system must be easy, clear, and fast.
 - a. The activities on the roof must be limited as far as possible.
 - b. The installation process must be intuitive and well described by guidelines.
 - c. The system must prevent wrong installation.
 - d. Installation time of one panel with two persons must be less than two hours, excluding (roof) preparation and in-house connecting to the heating system.
19. The installation process must take place under Arbo approved conditions.
 - a. The weight of the panel must be less than 25 kg if it is to be lifted by one or two persons.
 - i. If the panel must be placed by a crane – and therefore is not lifted by one or more persons – the weight can be higher than 25 kg.
 - b. The installer must be prevented from electrical shocks.
20. The panels must be able to connect to the regular heating system following existing standards.
 - a. Pipes from the panel to the boiler must have a diameter of 15 mm [45].
 - b. According to NEN-EN 12976-1 the panel must be able to withstand a test pressure for the working fluid of 1.5 times the operating pressure [46].
21. The system must be able to connect to the public electricity grid following existing standards.
22. All cables and pipes coming from the panel(s) must be put through the roof through a single opening.
23. The system or parts of it may not shadow the PV cells.
24. When the system is installed, it must be protected against theft.

5.6. Manufacturing and storage

25. The system is preferably manufactured locally (in the Netherlands), automated, and in mass-production.
26. Standard components and processes are used as much as possible.
27. The system must be transportable by a standard truck to the building site or to the factory for prefab integration.
 - a. The systems should fit in a container of 12.0 x 2.3 x 2.2 m (length x width x height) [47].
 - b. Preferably more systems fit in a truck at the same time.
28. The system must resist the conditions on the building site, including (fine) dust, lifting and dragging by cranes and persons, and accidentally bumping into objects.

5.7. Operation and maintenance

29. The minimum life time of the panel is 25 years.
 - a. Components of the complete system may have a shorter life time, if they are cheap and easy to replace.
30. The system must be easy to maintain.
 - a. Components must be easy reachable for maintenance, reparation, or replacement.
 - b. The panel must be self-cleaning due to rain water rinse out.
 - i. It is advisable to prevent rain water from higher parts to flow over the panel, since this will cause new pollution.
31. Monitoring of the system must be possible [45].
 - a. The installation company must be able to check the functioning of the system once or twice a year.
 - i. It is desirable that the check up takes place along with the check up of the central heating unit.
 - b. The occupant must be able to receive feed back about the functioning of the system on a daily basis.
 - i. The habitant must be able to see if the system is working properly.
 - ii. The habitant must be able to get information about the performance and/or energy savings of the system.

Part II: Design

“Design is not just what it looks like and feels like. Design is how it works.” – Steve Jobs

6. Generation of ideas

The goal of the idea generation phase is to generate as many ideas as possible about the new solar panel. These ideas may deal with a specific part of the panel or with the panel as a whole. To stimulate the generation of ideas, different brainstorm techniques are being used. To further increase the number of ideas, also some informal brainstorm sessions have been organised for two to five persons, with and without design experiences. In this section, first the brainstorm techniques used will be explained, after which the ideas will be presented in a morphological scheme. The ideas will be further developed in the next chapters.

6.1. Brainstorm techniques

The brainstorm techniques that have been used during the idea generation are TRIZ and different association techniques. The basic principle of association techniques is to find similar problems in another context. For example, to come up with ideas about how to connect the panels thermally, one can look at how this is done in solar thermal collectors and central heating systems, but also at flow systems in industry and the connection of the garden hose. At first sight these situations may appear to have little or no common interest with the solar panel, but ideas from another context can often be translated to the desired situation.

As an extension to the association techniques, a tool called '37 ways for new product ideas' [48] is used. For this tool successful innovations have been ordered and linked to underlying trends, principles, and evolutions. To help look outside the box, the tool makes you think of questions like *How can you make this an IKEA product?*, *How would Apple design this product?* and *How can you make the product more communicative?*. The tool can be used for new product ideas and for improving existing products.

The other brainstorm technique used is TRIZ [49], which is the Russian acronym of Theory of Inventive Problem Solving. TRIZ is a systematic approach to innovate and is based on reviewing thousands of patents. This review showed that innovative ideas are almost always the result of solving a technical or physical contradiction. For example, to reduce the weight of the solar panel (+) the glass covering could be removed. However, this will lead to a lower thermal yield (-), resulting in a contradiction that has to be solved. In the TRIZ Matrix of Contradictions 39 general system features are listed, such as weight, temperature, and reliability. Each combination of these system features shows one or more of the 40 inventive principles of TRIZ which are most frequently used in patents to solve the contradiction. For the example given above, the system features are weight and productivity. The corresponding inventive principles involve among others *segmentation* (e.g. divide the panel into independent parts) and *using another dimension* (e.g. use a corrugated surface to capture more light). Besides the contradictions, TRIZ also uses trends of evolution. Again based on patent reviewing it has shown that products follow certain trends while they evolve in time. The trends can be used to predict how products will develop in time.

6.2. Morphological framework

The ideas generated are categorised into several topics. Each topic addresses a design question that needs to be answered:

- How does the shape of the panel fit to the different shapes of the roofs?
- How is the joining between the panels and between the panels and the roof?
- How can the panels be attached to the roof?
- How can the panels be thermally connected?

These questions lead to two more questions that come back in all questions before:

- How to deal with different dimensions on the roofs?
- How is the flow pattern inside the panel and where are the connection points?

A schematic overview of the relations between the different topics is given in the following figure. Starting point is the integration of the panels in the roof. The panel's shape and the materials used are the main indicators for the level roof integration. The panel's shape largely influences the thermal, electrical, and physical connection between the panels and between the panels and the roof. At their turn the different connections influence the way the panels can be attached to the roof and the way the water flows inside the panel, which is part of the working principle. In the end, all topics have an influence on the shape of the panels and on the roof integration.

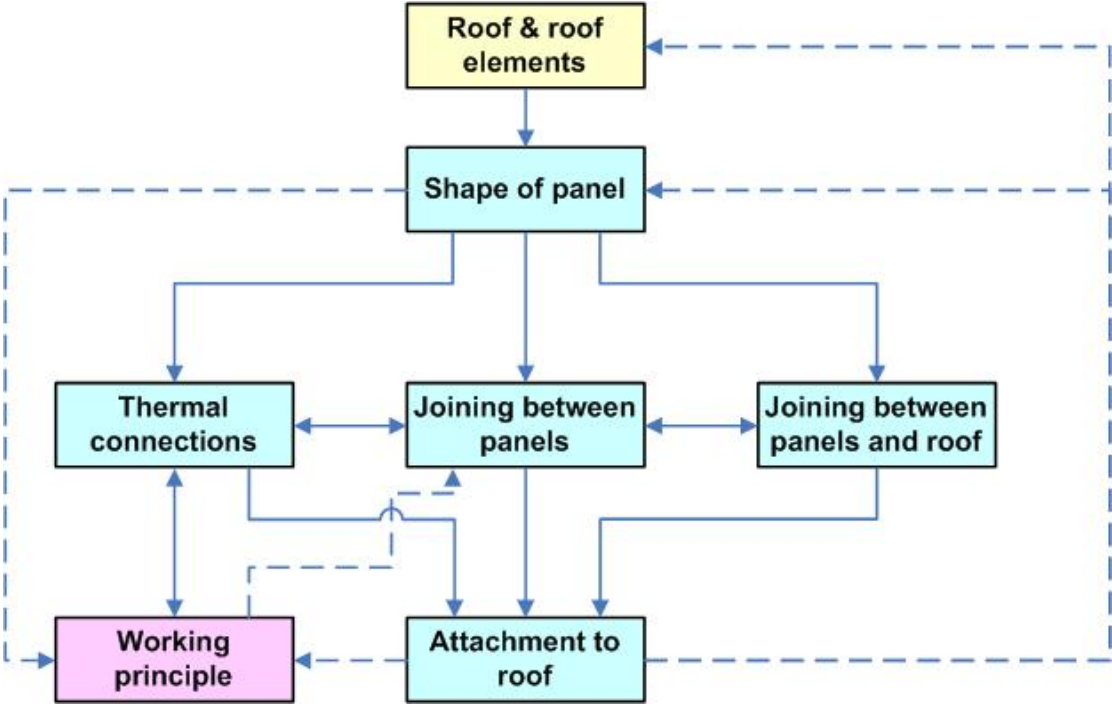

Figure 27: Schematic overview of the relations between the idea topics

The ideas generated are collected in the morphological framework on the next page. More ideas and explanations can be found in Appendix E.

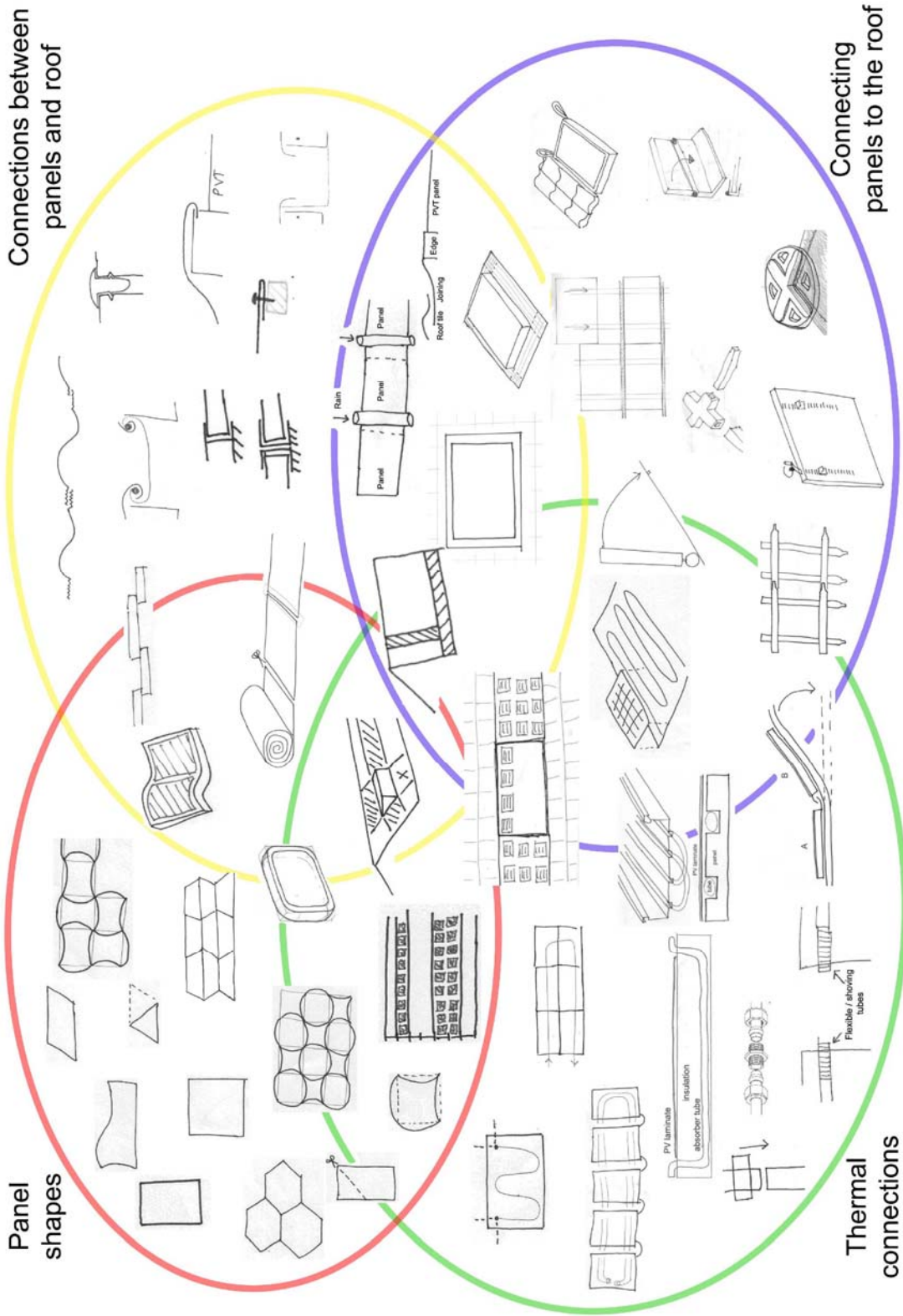
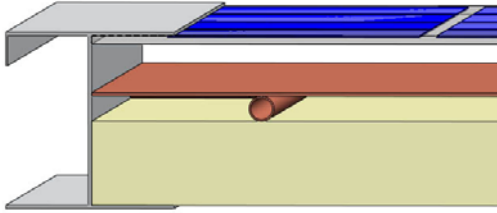
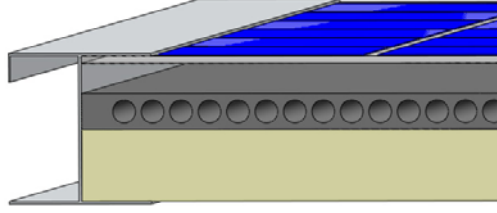
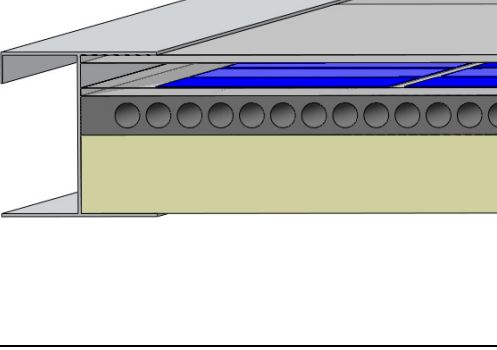
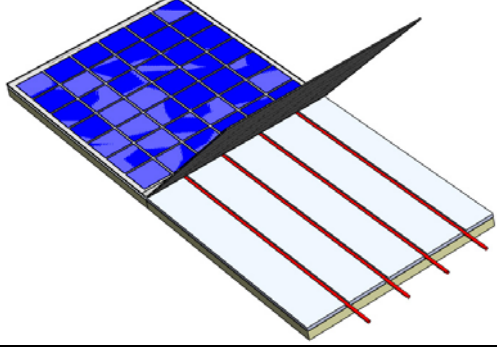
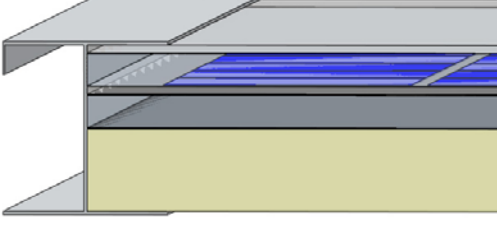
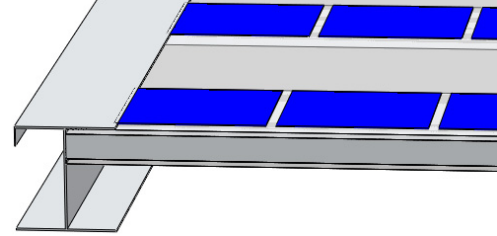

Figure 28: Morphological framework

Based on the morphological framework, different working principles can be distinguished, which are depicted in Table 5. The choice for a working principle will influence the performances and costs of the design, but also other aspects, like the connections and joining between the panels. The relations between the different topics – as shown in Figure 27 – will therefore be used during the entire design process.

Table 5: Different PVT working principle

<p>1</p> 	<p>2</p> 
<p>Sheet-and-tube copper absorber. There is an air layer between the PV laminate and the absorber.</p>	<p>Channel plastic absorber. There is an air layer between the PV laminate and the absorber.</p>
<p>3</p> 	<p>4</p> 
<p>Channel plastic absorber. The PV laminate is glued onto the absorber.</p>	<p>Copper sheet and plastic tubes absorber. First flexible tubes are placed to collect the heat. On top of them PV laminate is placed.</p>
<p>5</p> 	<p>6</p> 
<p>Channel copper absorber. Heat is collected by the water layer between the copper absorber and the PV laminate.</p>	<p>Skylight which is partly covered with PV cells and a sheet-and-tube copper absorber. The other part is transparent like normal windows.</p>

7. Idea detailing

The ideas from the morphological scheme detailed, extended, and be combined to form concepts. This chapter will describe the detailing and extension of the ideas for the connection points, joining system, and working principle. The section about the working principle is based on simulations to get insight in the thermal and electrical performance, the costs, and the weight of the panel. Based on the detailed ideas, concepts are developed which will be presented in the next chapter.

7.1. Connection points

The number of connection points and their positions at the panel are important factors, which determine how the panels can be connected thermally and physically. Especially the thermal connection points must be chosen in a logical position for an easy installation. There is not one best setting for all situations; panels with two connection points are generally easier to manufacture, but panels with four connection points have more flexibility in positioning the panels. This section describes the considerations concerning the thermal connection points. Since the electrical connections are expected to have less influence on the design, the electrical connection points will be considered later in the detailed design.

The panels can be installed in rows, columns, and a combination of these two. For an easy installation, the installer should not have to puzzle with many different types of panels: one type would be best, but two or three variations may still be acceptable. The tubes connecting the panels should be as short as possible, to prevent large heat losses.

Figure 29 shows the possibilities for the thermal connection points. The long and short edges of the panel can be exchanged. Distinction can be made between fixed and flexible connection points. Fixed points always face the same direction, while flexible points can face two directions, depending on what is best for the installation.

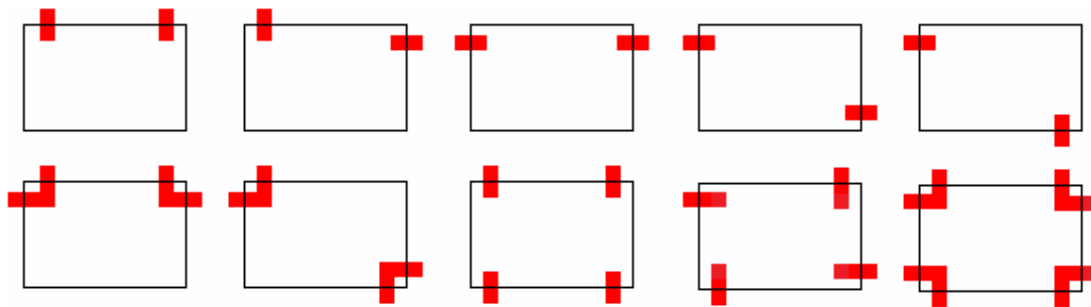

Figure 29: Possible positions of the connection points

The different positions of the connection points will be compared to each other. It must be possible to connect different numbers of panels, but for the examples a set of 2 x 3 panels is used. All panels get connected in series to minimise the amount of tubes outside the panels. The in- and outlet of the complete system are not indicated in the examples, since the tubes can be interrupted at any point to position the in- and outlet.

Compared to two connection points, four points give more possibilities for connecting the panels and will lead to shorter tubes outside the panels, as can be seen in Figure 30. However, four connection points will also be more difficult to manufacture and may cause more mistakes, since the installer has to open or close some connections points. This must be kept in mind when a panel with four connection points will be designed.

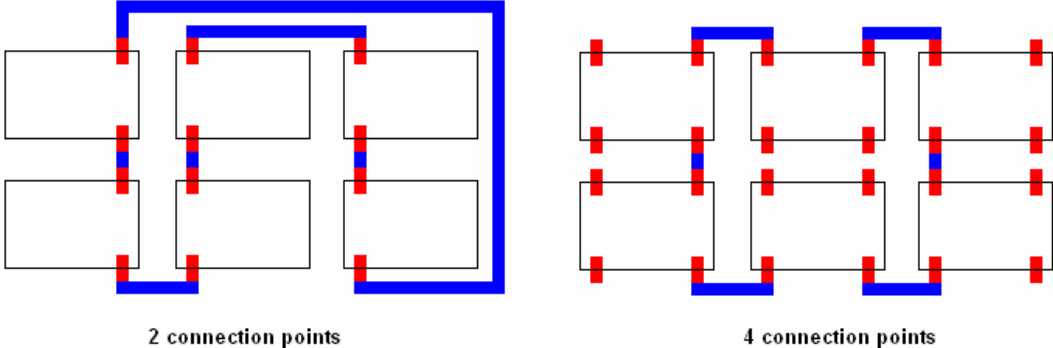

Figure 30: Two vs. four connection points

Looking at the advantages of flexible connection points above fixed ones, the flexible connection points need fewer tubes to connect the panels. Figure 31 gives an example of how panels can be connected using flexible connection points. If this figure is compared to the fixed connection points of Figure 30, it can be seen that the amount of tubes saved is very limited. The extra effort needed to set the flexible connection points to the right direction and the extra costs for manufacturing do not justify this limited advantage of less tubes needed.

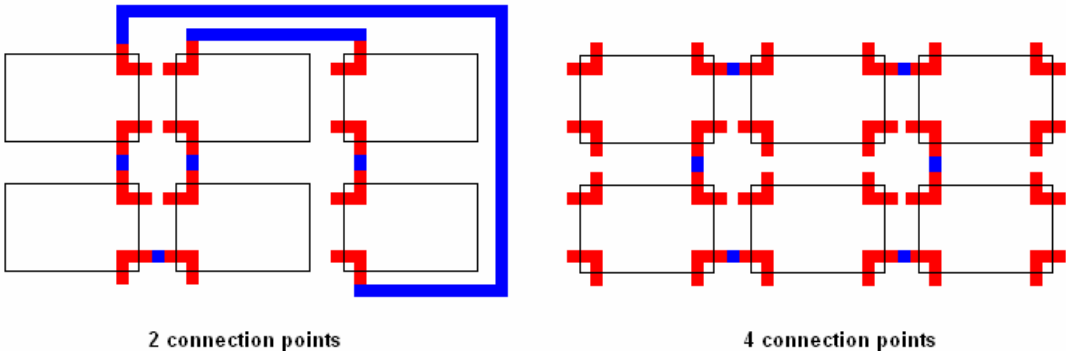

Figure 31: Flexible connection points

When looking at the panels with two connection points, there is a difference between the panels with the connection points at the right corners of the panel (left in Figure 32) and the panels with the connection points at a diagonal (right in Figure 32). It appears that the panels with connection points at a diagonal need as much as or more tubes outside the panels than the panels where the connection points are at the same edge. This does not only hold for the given configuration (2 x 3 panels), but for all configurations. It can be concluded that – when using 2 connection points – the connection points must be positioned at adjacent corners.

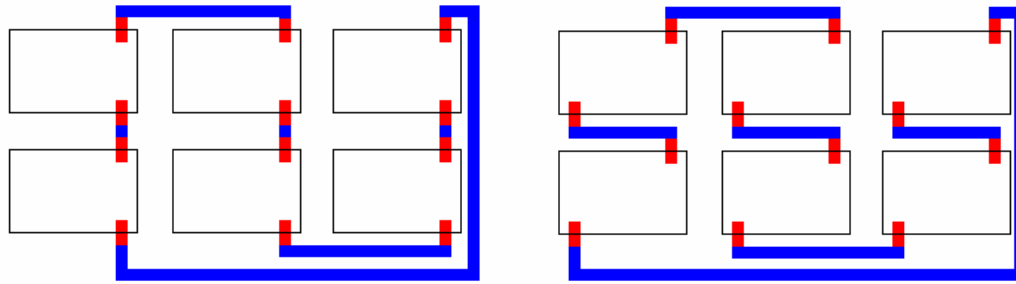

Figure 32: Two connection points at one edge or at a diagonal

Since it seems that quite a few tubes are needed outside the panels to thermally connect them, it may be an option to use an extra tube inside the panel, which is used to guide the water back to the starting point. This could look like depicted in Figure 33, where the green lines represent the extra tubes inside the panel. Compared to the situation in Figure 32 indeed less tubes are needed outside the panel. However, the flow pattern has become much more complex, which makes it hard for the installer to see which points need to be connected. The fact that not all extra tubes are used – in Figure 33 only green lines in the middle panels and the bottom left panel are connected – makes the installation even more complicated. To get all the advantages of the extra tubes inside the panel, they should be placed both in the length and width of the panel, since the set of panels can be extended in both directions. This makes installation even more complex.

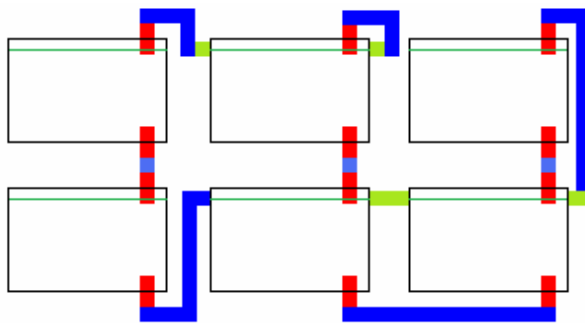

Figure 33: Extra tubes inside the panel

Extra tubes inside the panels may be a good option considering the thermal yield and the roof integration, but looking at the installation process this is far too complex.

Concluding, two or four fixed connection points will be used to thermally connect the panels. The exact direction of the connection points is not determined yet, but if two connection points are used, they should be placed at adjacent corners.

7.2. Joining system

Besides the thermal (and electrical) connection, the panels should also be physically joined. There are many joining systems possible and the best choice is largely influenced by other design decisions like the panel's dimensions, working principle, and thermal connections. The intention of the joining systems is to physically join the panels and (help) attach them to the roof. An important boundary condition is that the roof must remain waterproof. In this section different possibilities for the joining system will be described.

The easiest system to join the panels is depicted on the left of Figure 34. The panels themselves are finished waterproof and I-profiles are used to make the changeover between the panels. With this joining system the panels are positioned very close together, which gives a smooth impression. A disadvantage of this system is that the connection points can not be reached. It is therefore difficult to see if the panels get properly connected.

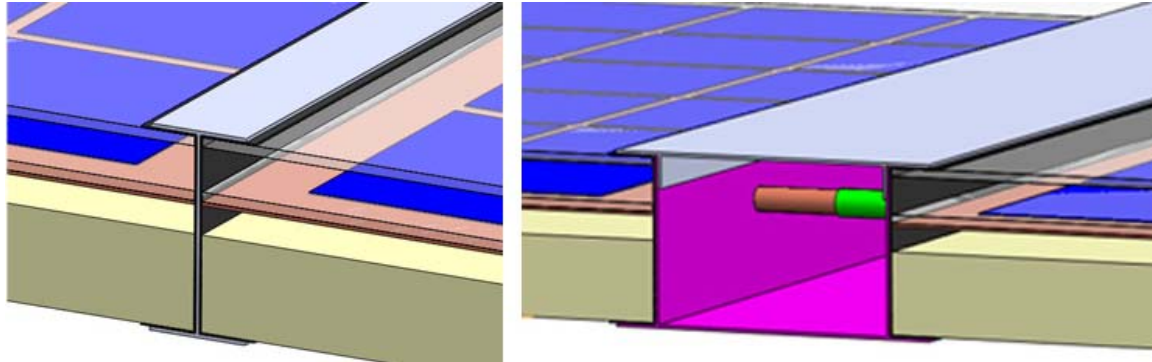

Figure 34: Cross-section of a joining system with simple I-profiles (left) and broadened profiles (right)

To adapt to this problem, the I-profile can be broadened as is shown at the right of Figure 34. There is now space available to connect the tubes from the two panels. The profile can be closed to make a smooth changeover between the panels.

Using a limited amount (two or four) of PVT panels it is possible to place the panels in a frame that is attached to the roof. If the frame is positioned correctly, the panels can just be slid into the frame, without the need to position each panel by itself. This is depicted in Figure 35. The thermal connections between the panels are easily realised. At the left and right sides an extra profile is placed to close the frame. The outer edges of the frame can have a simple joining rail to extend the system with PV panels.

This joining system can also be used for larger amounts of panels, using multiple frames for two or four panels. These frames will have to be positioned in relation to frames already installed. This however partly reduces the advantage of the system. It is not advisable to use larger frames, since they will be difficult to handle on the roof due to their dimensions.

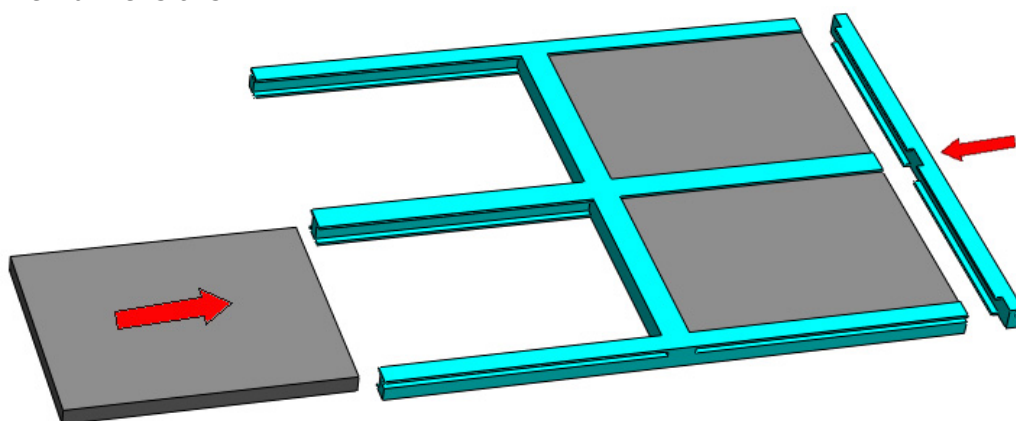

Figure 35: One joining frame for four PVT panels

When more than four panels are used, it may be better to use a comparable joining system. Guiding rails can be attached to the tile laths horizontally or vertically. If the rails are positioned correctly, the panels only need to be positioned in the linear direction of the rails. Figure 36 shows an example of what this could look like if the panels can be joined in both length and width.

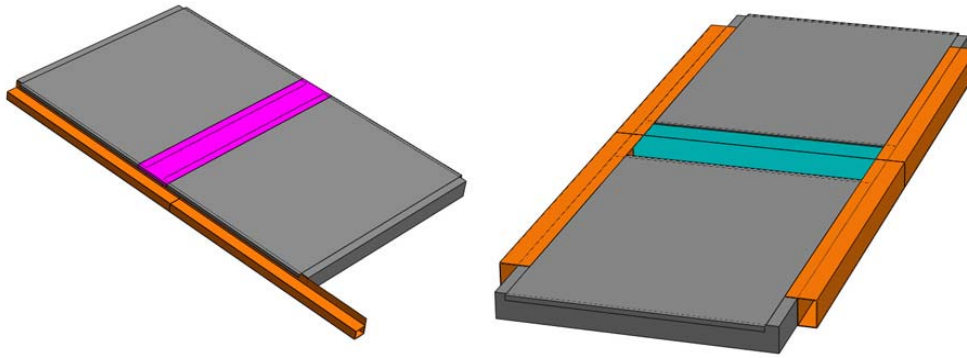

Figure 36: Joining system with guiding rails

Another possibility is to adapt the current gutter parts, so that these can be used as the joining system. The changeover between the panels now shows a gap, but the installation is very easy. The panels can be attached to the roof, after which the gutter parts are placed to keep the roof watertight.

One more option is to place panels in the frameworks of skylights. The advantage of using skylight frames is the known process to install these frames waterproof in the roof. Furthermore, these frames often have possibilities to connect multiple frames next to each other, in an aesthetically acceptable way. A disadvantage is that the insulating function of the roof is affected, like with skylights.

All joining systems presented have their advantages and disadvantages. Since there is not one best solution, the definitive choice for a joining system is not made yet.

7.3. Physical working principle

Within this section different possibilities for the physical working principle of a liquid PVT panel will be compared. Simulations are used to predict the thermal and electrical performance, weight, and costs of different working principles. This section describes the model and settings used for the simulations, followed by the results and conclusions for the design of the panel.

The reference PVT panels consist of a PV laminate glued on a copper tube-and-sheet absorber. A glass covering reduces the heat loss. This working principle is depicted in Figure 37.

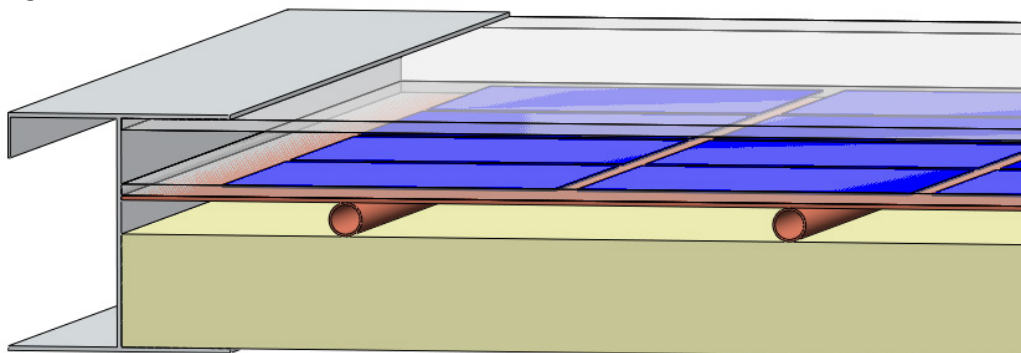

Figure 37: Working principle of the reference PVT panel

It is possible to use other working principles for the new PVT panel, which may lead to a lower weight, lower costs, an easier installation, or an improved charisma. The working principle can be varied by using other materials, adding water and/or air layers, or by separating the thermal and electrical part of the collector. Besides, each working principle can be covered or uncovered with a glass layer to reduce heat losses.

7.3.1. Model for simulation

To simulate the different working principles an existing one dimensional steady-state model is used [50]. Within this model the heat flows through the different layers in the panel are analysed. Figure 38 shows the cross-section of the reference PVT panel, including these heat flows and the temperatures at different points. Convection, radiation, and conduction are taken into account. Furthermore, the heating of the flowing water results is a heat flow outside the panel. The parameters used in the simulations are listed in Appendix F.

Instead of a serpentine curving tube on a flat sheet, the sheet-and-tube absorber is modelled as one long, straight tube on a long and small flat sheet.

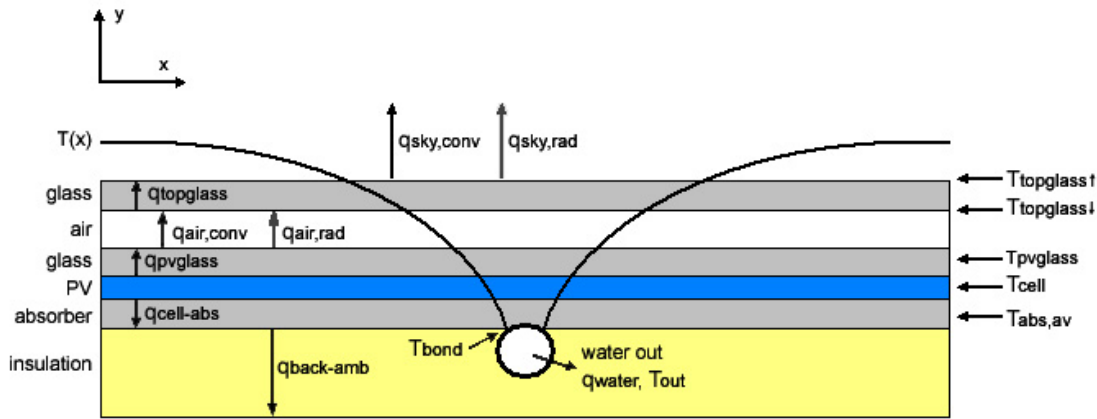

Figure 38: Simulation model

The heat flows of the different layers are represented by the following equations:

$$q_{\text{water}} = \dot{m}c(T_{\text{out}} - T_{\text{in}}) \quad (4)$$

$$q_{\text{sky,rad}} = F_{\text{sky}}\epsilon_{\text{glass}}\sigma(T_{\text{topglass}\uparrow}^4 - T_{\text{sky}}^4) + F_{\text{earth}}\epsilon_{\text{glass}}\sigma(T_{\text{topglass}\uparrow}^4 - T_{\text{a}}^4) \quad (5)$$

$$q_{\text{sky,conv}} = h_{\text{wind}}(T_{\text{topglass}\uparrow} - T_{\text{a}}) = \frac{Nu_{\text{wind}}k_{\text{air}}}{L_c}(T_{\text{topglass}\uparrow} - T_{\text{a}}) \quad (6)$$

$$\bullet \quad q_{\text{air,rad}} = \epsilon_{\text{eff}}\sigma(T_{\text{pvglass}}^4 - T_{\text{topglass}\downarrow}^4) \quad \text{with } \epsilon_{\text{eff}} = \frac{\epsilon_{\text{glass}}\epsilon_{\text{pv}}}{\epsilon_{\text{glass}} + \epsilon_{\text{pv}} - \epsilon_{\text{glass}}\epsilon_{\text{pv}}} \quad (7)$$

$$q_{\text{air,conv}} = h_{\text{air}}(T_{\text{pvglass}} - T_{\text{topglass}\downarrow}) = \frac{Nu_{\text{air}}k_{\text{air}}}{H}(T_{\text{pvglass}} - T_{\text{topglass}\downarrow}) \quad (8)$$

$$q_{\text{back-amb}} = h_{\text{back-amb}}(T_{\text{abs,av}} - T_{\text{a}}) \quad (9)$$

$$q_{\text{cell-abs}} = h_{\text{cell-abs}}(T_{\text{cell}} - T_{\text{abs,av}}) \quad (10)$$

$$q_{\text{pvglass}} = \frac{k_{\text{glass}}}{\delta_{\text{pvglass}}}(T_{\text{cell}} - T_{\text{pvglass}}) \quad (11)$$

$$q_{\text{topglass}} = \frac{k_{\text{glass}}}{\delta_{\text{topglass}}}(T_{\text{topglass}\downarrow} - T_{\text{topglass}\uparrow}) \quad (12)$$

In accordance with the law of conservation of energy, the following heat balance equations are added:

$$q_{\text{water}} = q_{\text{cell-abs}} - q_{\text{back-amb}} \quad (13)$$

$$q_{\text{cell-abs}} = (\tau_a - \tau_{\text{pv}} \eta_{\text{el}}) G - q_{\text{pvglass}} \quad (14)$$

$$q_{\text{pvglass}} = q_{\text{air,conv}} + q_{\text{air,rad}} \quad (15)$$

$$q_{\text{air,conv}} + q_{\text{air,rad}} = q_{\text{topglass}} \quad (16)$$

$$q_{\text{topglass}} = q_{\text{sky,conv}} + q_{\text{sky,rad}} \quad (17)$$

The 14 equations contain nine unknown heat flows and six unknown temperatures (T_{out} , T_{cell} , T_{pvglass} , T_{abs} , $T_{\text{topglass}\uparrow}$ and $T_{\text{topglass}\downarrow}$). Therefore one more equation is needed to solve the problem. This extra equation gives the average absorber temperature in the x-direction of the panel, as indicated in Figure 38:

$$\bullet \quad T_{\text{abs}}(x) = T_a + \frac{(\tau_a - \tau_{\text{pv}} \eta_{\text{el}}) G}{U_{\text{loss}}} + \cosh(mx) \frac{T_{\text{bond}} - T_a - (\tau_a - \tau_{\text{pv}} \eta_{\text{el}}) G / U_{\text{loss}}}{\cosh(m(W-D)/2)}, \quad (18)$$

with

$$m \equiv \sqrt{U_{\text{loss}} / k \delta_{\text{abs}}} \quad (18.a)$$

$$U_{\text{loss}} = \frac{q_{\text{sky,rad}} + q_{\text{sky,conv}} + q_{\text{back-amb}}}{T_{\text{pvglass}} - T_a} \quad (18.b)$$

$$T_{\text{bond}} = T_{\text{water}} + \frac{q_{\text{water}}}{h_{\text{tube}}} = T_{\text{water}} + \frac{q_{\text{water}} D}{\text{Nu}_{\text{tube}} k_{\text{water}}} \quad (18.c)$$

Solving the equations will give a number of values for the electrical and thermal efficiency as a function of the reduced temperature, which is defined as:

$$T_{\text{red}} = \frac{T_{\text{in}} - T_{\text{amb}}}{G} \quad (19)$$

The data points can be used to plot a thermal efficiency curve, of which Figure 39 shows an example. To reduce simulation times, within this model the thermal efficiency is assumed to decrease linear with temperature, which gives a small deviation from the actual situation. From the (linear) efficiency curve, the parameters η_0 (efficiency a zero-reduced temperature) and η_1 (slope) can be determined. With these parameters the yearly thermal yield can be simulated.

There is no official standard (yet) to determine the thermal yield of PVT panels. Therefore the same system settings are used for all simulations, to make the comparison between the different configurations as fair as possible. Based on hourly data for the irradiation and the ambient temperature, and a standardised demand pattern for hot tap water, the yearly thermal yield can be determined. For a better comparison between thermal and electrical yield, the thermal yield is converted from GJ/m² to kWh/m² using the conversion factor 1 GJ = 278 kWh.

For the electrical yield, for each time step of the simulation the temperature of the PV cells is calculated and used to determine the PV efficiency. Based on hourly data for the irradiation, the yearly electrical yield is calculated.

The wind speed is expected to have a significant influence of the thermal efficiency. However, during the simulations the wind speed can not be varied, since this would make the model too complex for the results needed within this thesis. The influence of the wind speed will be taken into account by running each simulation twice, while only changing the wind speed.

An indication of the panel's weight is obtained by multiplying the material's density and volume, and summing over all materials. An indication of the costs is gained by multiplying the materials' prices and volumes. The assembly costs are assumed to be 10% of the total material costs. The indication of the costs does not include the costs for the casing and the installation costs, since these are highly dependent on the number and dimensions of the panels.

7.3.2. Simulation settings

The constant settings used in the simulations – including the material costs – are listed in Appendix F. For the hot tap water demand a standard demand pattern for households is used as a reference [51]. This pattern implies a hot tap water demand of 117 litres per day of 60°C. For practical use in the simulations the demand pattern is converted to discrete steps of 15 minutes. To simulate the environmental settings the Test Reference Year from 1984 is used [52]. The data sets of the Test Reference Year used originate from the Royal Dutch Meteorological Institute (KNMI) in the Netherlands and describe the weather conditions in De Bilt. The daily course of the hot tap water demand and the irradiation on a winter and a summer day are visualised in Figure 40.

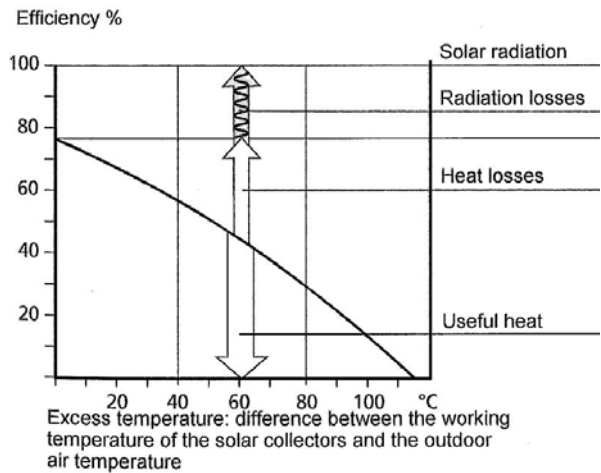

Figure 39: Thermal efficiency as a function of temperature [7]

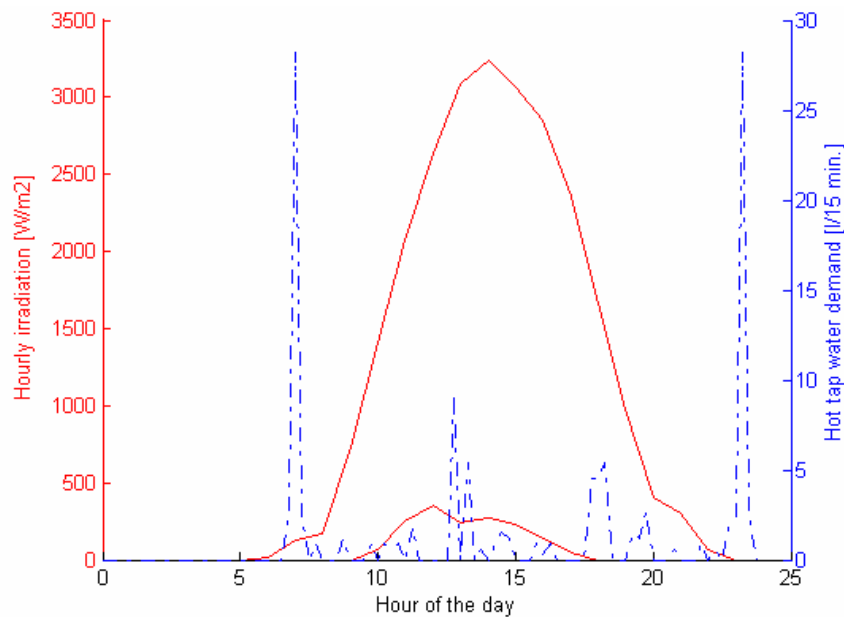

Figure 40: Solar irradiation on a winter and summer day (1 January and 1 July) in relation to the average hot tap water demand of a Dutch household during the day

The calculations and simulations are performed using MATLAB. Within ECN MATLAB files were available to simulate the thermal and electrical efficiency of PVT panels [53]. These files are updated and adapted for use within this thesis. Furthermore, the files are extended to give an indication of the panels' weight and costs per m².

To simulate the working principles shown in Table 5, six different configurations have to be simulated. These configurations differ in the absorber that is used (copper sheet-and-tube or plastic channel absorber), how the PV laminate is positioned in relation to the absorber (glued together or separated by an air layer), and the presence of a glass covering (glazed or unglazed). For a complete plastic panel, one configuration is added where a plastic covering is used instead of glass. The variations between the simulated configurations are listed in Table 6. Each configuration will run with a wind speed of 1 m/s and with 10 m/s. The average wind speed in the Netherlands is 4 m/s [54].

Table 6: Variable settings for the simulations

Set	Absorber	PV and absorber are	Covering	Example
0	Copper	Glued	Glass	Figure 37
A	Copper	Glued	-	Table 5 – figure 6
B	Copper	Separated by air layer	Glass	-
C	Copper	Separated by air layer	-	Table 5 – figure 1
D	Polyethylene	Glued	Glass	Table 5 – figure 3
E	Polyethylene	Glued	-	Table 5 – figure 4
F	Polyethylene	Glued	Polycarbonate	Table 5 – figure 3

Figures 2 and 5 of Table 5 are not mentioned under the examples in Table 6. For time reasons, a first indication of configuration 2 can be derived from the results of sets C and D. If this is promising, the actual configuration 2 will be simulated. Configuration 5 will not be used in the design, since it appears that a very thick glass layer (8 mm) is needed to resist the water pressure [55]. This would make the panel too heavy.

The simulation model for the (plastic) channel absorber slightly differs from the model for the (copper) sheet-and-tube absorber. The most significant change is that the main heat transfer resistance is no longer at the changeover between the PV laminate and the absorber, but at the changeover between the absorber and the water. All constant settings remain equal.

7.3.3. Simulation results

Figure 41 shows the thermal yield plotted against the electrical yield for the different simulation sets. First to be noticed is that set B is not present in the graph. The simulation of set B failed due to a convergence problem. Based on the results of the other sets, the results of set B are expected to be between the lines of set C and E.

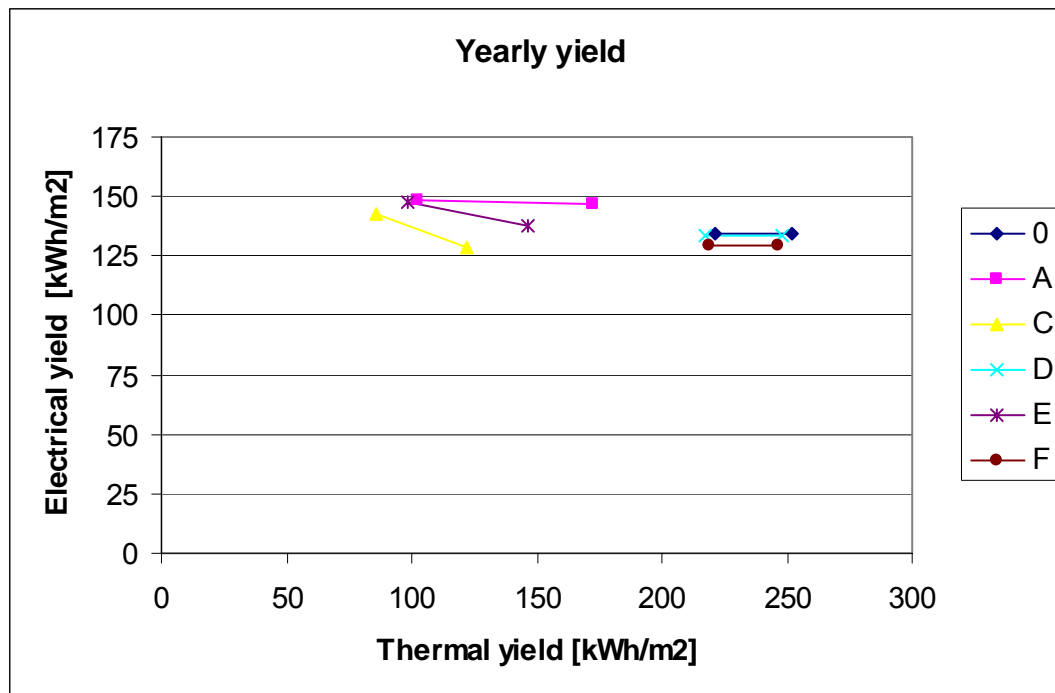

Figure 41: Yearly electrical and thermal yields of the different simulation sets

The next point of interest is the spread between the two points of each simulation. The right point of each set indicates the yield for a wind speed of 1 m/s; the left points show the results for a wind speed of 10 m/s. The figure clearly shows that the wind speed has a significant influence on the thermal yield, especially for the unglazed panels (A, C, and E). The absence of the glass covering also has a positive side. There are not reflection losses caused by the glass covering, which increases the amount of light falling onto the PV laminate and absorber and thereby increasing the efficiencies. Furthermore, the absence of the glass covering leads to cooling of the panel by the wind, which results in a higher electrical yield at higher wind speeds. This can be explained by the fact that crystalline silicon PV cells show a decreasing efficiency at increasing temperatures.

Looking at the glazed panels, replacement of a copper sheet-and-tube absorber (set 0) by a polyethylene channel absorber (set D) only has a very small effect of both the thermal and electrical yield. Replacing the glass covering by a polycarbonate covering (set F) has a slightly larger influence, which is mainly caused by the smaller transmission coefficient of plastics.

Figure 42 shows the weight distribution for the different concepts. The weight varies between 12 and 22 kg. Main contributors are the glass used for the covering and in the PV laminate. Obviously, glazed panels are heavier than unglazed panels. This effect can be reduced by replacing the glass by a plastic, like polycarbonate. The copper sheet-and-tube absorber weights about twice as much as the polyethylene channel absorber.

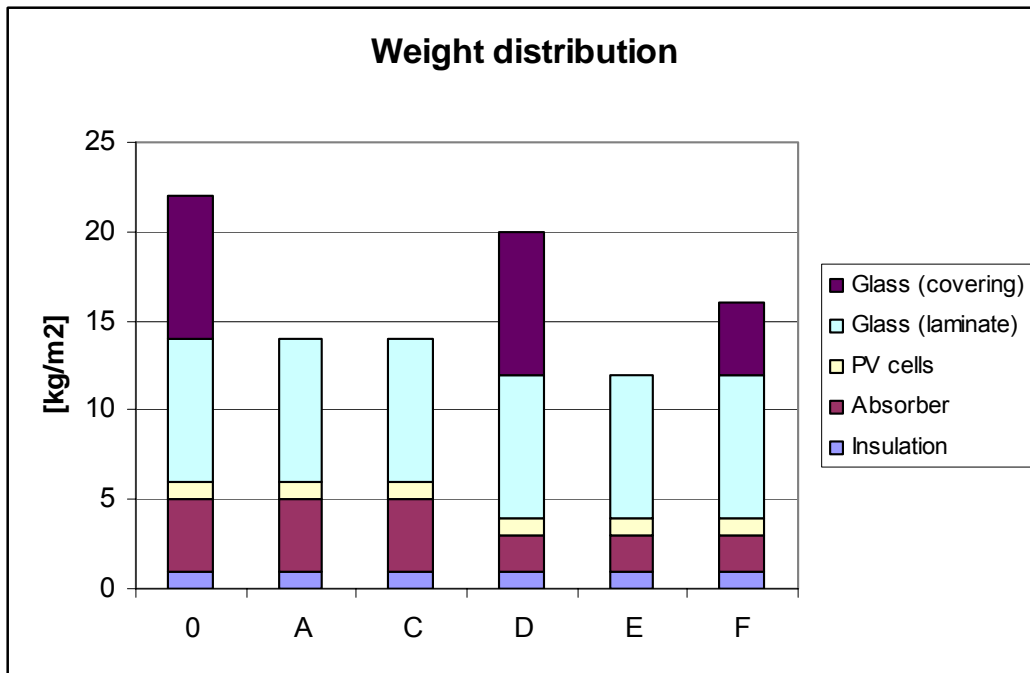

Figure 42: Weight distribution of the different simulation sets

Figure 43 shows the cost distribution for the different configurations. It clearly shows that the costs are mainly determined by the PV laminate. All configurations show a costs distribution of more than 80% for PV, 10% (assumed) for the assembly, and less than 10% caused by materials other than PV. Figure 44 shows a close-up of the cost distribution without the PV laminate.

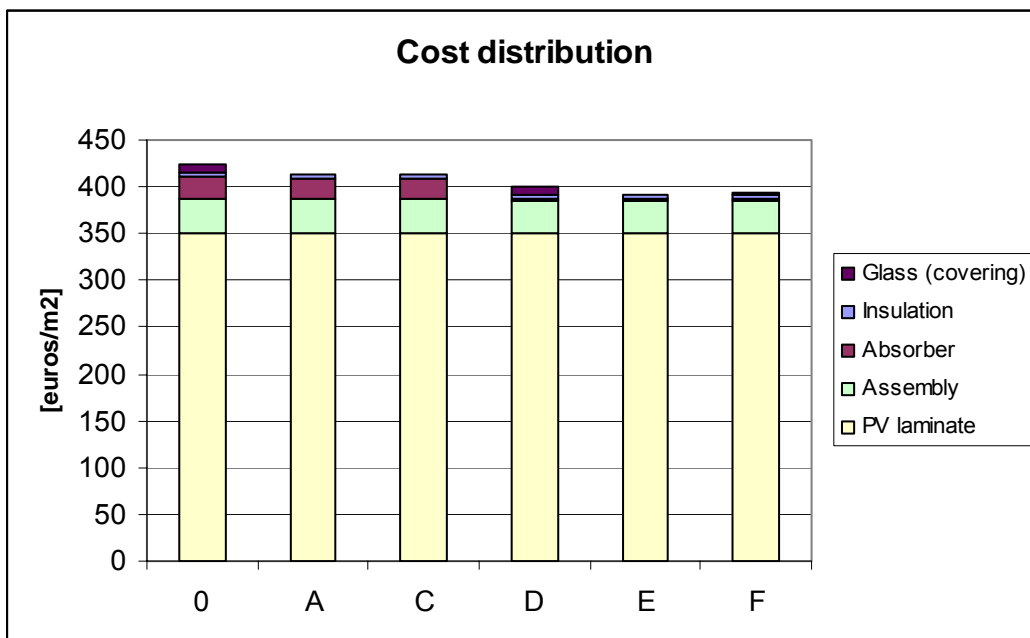

Figure 43: Cost distribution of the different simulation sets

The figure shows that the copper absorber is more expensive than the polyethylene absorber. Clearly glazed panels are a little more expensive than unglazed panels, since they have an extra glass layer. The costs of this covering layer can be reduced by using polycarbonate instead of glass.

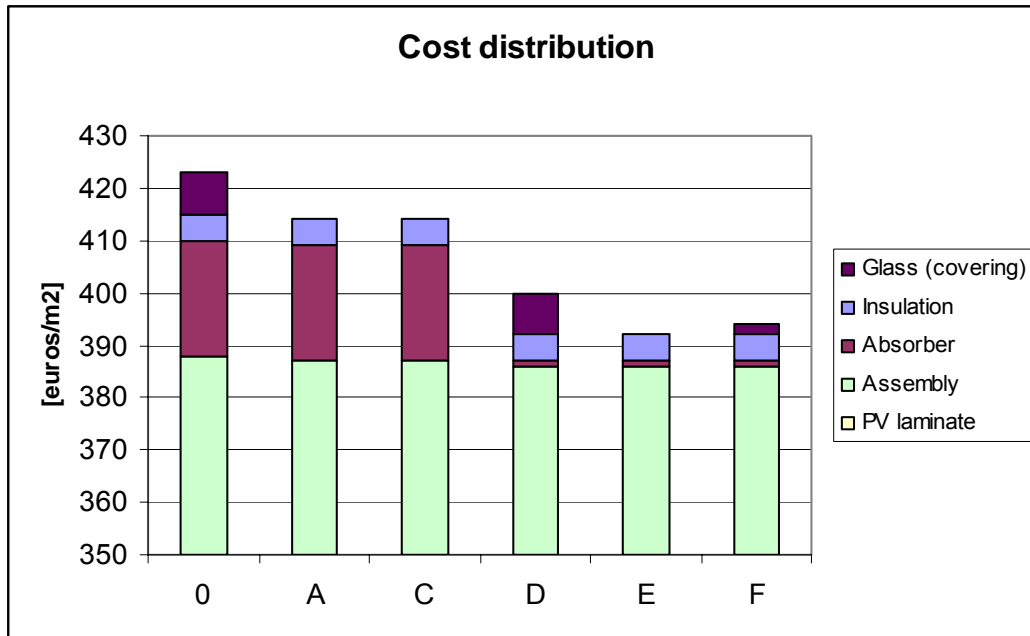

Figure 44: Close-up of the costs distribution of the different simulation sets

7.3.4. Conclusions and recommendations

Unglazed panels perform thermally significantly worse than glazed panels. The electrical yield of unglazed panels is however slightly higher compared to glazed panels. Unglazed panels are lighter in weight and a little cheaper.

Separation of the PV laminate and the absorber by an air layer has a negative effect on both the electrical and thermal efficiency. The situations where absorber and PV laminate are glued together have better performances and are therefore preferred. So, the configurations shown in figures 1, 2 and 4 of Table 5 (simulation sets C and E) will not be used.

The glazed copper sheet-and-tube panel and polyethylene channel panel (simulation sets A, D, and F) show comparable results for the thermal and electrical yield. If a plastic absorber is used, it is recommended to use a plastic covering as well, to benefit maximal from the lower weight and costs.

The weight of the panels varies between 12 and 22 kg/m². The main contributors to the weight are the covering glass layer and the glass used in the PV laminate. The copper absorber is a few kg heavier than the polyethylene absorber. The configuration shown in figure 5 of Table 5 will not be used in the design, since it is far too heavy.

The costs of the panel vary between 390 and 430 euros/m². More than 80% of these costs are for the PV laminate. Using plastics instead of copper and glass reduces the costs, but compared to the costs for PV the effect is very small.

For future simulations it is recommended to further detail the model which determines the costs and weight of the panels. At the moment only an indication is given, which is sufficient for this thesis. Furthermore, the determination of the thermal yield can be refined by a better approximation of the thermal efficiency curve, using a parameter η_2 for the second order effects. The determination of the electrical yield can be refined by a better estimation of the temperature of the PV cells.

7.4. Conclusions for design

Considering the thermal connection points, it is recommended to use two or four connection points. Two connection points are expected to be easier to integrate into the design, while four connection points offer more flexibility which makes it easier to connect the panels. Dependent on the focus of the design, a choice can be made between manufacturing and installation.

Looking at the joining system, there are several options available. The use of broadened I-profiles as depicted on the right of Figure 34 seems a simple and good option. Using guiding rails to attach the panels to the roof looks also promising, since the panels are automatically put into the right position. This makes the installation much easier. A third option for a joining system is to make use of frames for skylight. The panels can then be used instead of a normal window.

Combining all topics from Figure 27 and the considerations presented in this chapter, three concepts are developed, which will be presented in the next chapter.

8. Concept design

Based on the ideas described in the previous chapters, three concept designs for the PVT panel have been developed. The concepts have been named *Traditional*, *Plastic*, and *Skylight*. In this section the different concepts will be discussed. Based on a multi criteria analysis the best concept will be chosen to be further developed in the next chapter.

8.1. Concept Traditional

The focus of this concept is on matching the energy demand of a household. This means that efficiency and the possibility to join many panels are the most important aspects.

Of the three concepts, this one looks the most like the reference PVT panel. The panel consists of a PV laminate glued on a copper sheet-and-tube absorber. The panel is covered with a layer of glass. A cross-section of the inside of the panel is depicted in Figure 45.

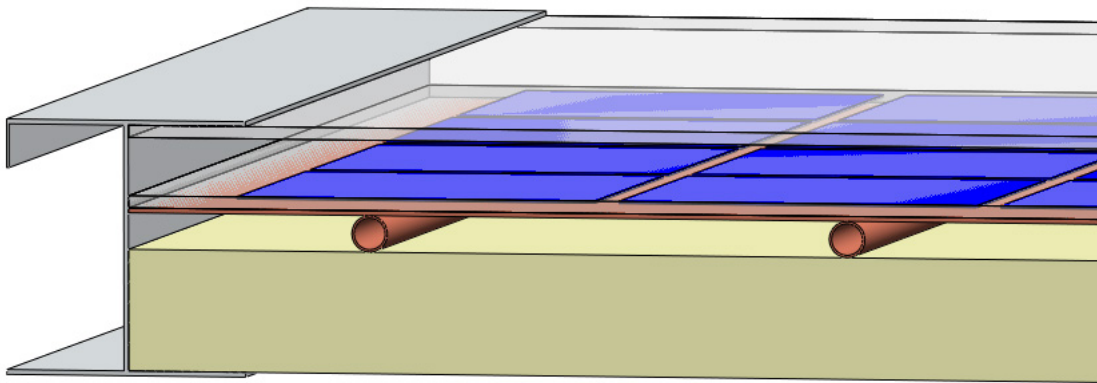

Figure 45: Cross-section of concept *Traditional*

Based on the simulations of the performances (set 0 in Figure 41), this panel is expected to have a PV efficiency of 13.5% and a thermal yield between 3.6 and 3.2 GJ/year with an area of 4 m². Following equations 20 and 21 and assuming an average hot water demand of 8 GJ/year and heat storage without energy losses, 9.4 m² PVT panels and 16 m² of PV panels are needed to cover the average household's energy demand with these panels.

$$\text{AreanEEDED} = \frac{\text{Energyneeded}}{\text{Thermalyield/m}^2} = \frac{8[\text{GJ/yr}]}{3.4/4[\text{GJ/m}^2\text{yr}]} = 9.4[\text{m}^2] \quad (20)$$

$$\text{AreanEEDED} = \frac{\text{Energyneeded}}{\text{Electricalyield/m}^2} = \frac{3402[\text{kWh/yr}]}{1,000[\text{kWh/m}^2\text{yr}] \cdot 0.135} = 25[\text{m}^2] \quad (21)$$

Each panel has two connection points. The panels can be joined in rows, columns, or a combination of both as shown in Figure 46. The installer has to connect the panels by installing extra tubes in the gutters of the panel. For the short distances standard components can be used. For the longer distances handmade installation may be necessary, since the large tolerances on the roof will make each situation unique. The amount of handmade installation must be put to a minimum to prevent long installation times and high costs.

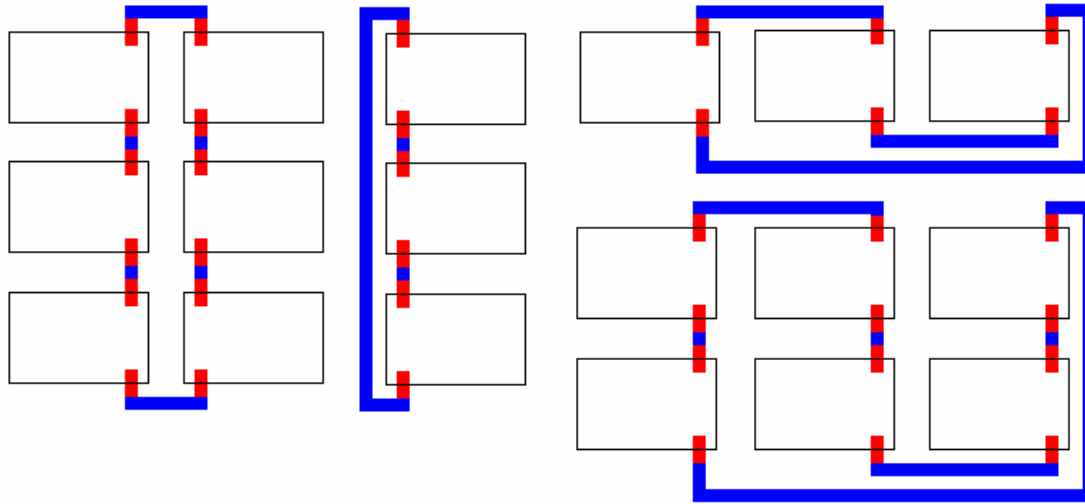

Figure 46: Connection points of concept *Traditional*

The panels are physically joined with a joining system which consists of several extrusion profiles. The system is depicted in Figure 47. First, the joining rails (green) are attached to the roof. The ends of the rails can be clicked together to form one long rail and they can be placed horizontally or vertically. The panels (grey) can then easily be slid between the joining rails, see Figure 48. When the joining rails are positioned correctly, the panels will automatically be in the right position as well. Perpendicular to the joining rails, the panels are joined by a flexible gutter (purple). Because of its flexibility, the gutter can easily be positioned under the edges of the panels, as is shown in Figure 49. Special gutter parts (blue) are used for the changeover between the panels and the roof tiles.

The connection points of the panels are facing the joining rails. These are provided with holes to make the thermal connections. The top part of the rails can be lifted to reach the connection points. The extra tubes outside the panels are placed in the flexible gutter parts. For a nice finish, special strips can be placed to close the gap above the flexible gutter. The top level of the panels and the joining system is now completely flat, since the joining rails are sunken in the panels.

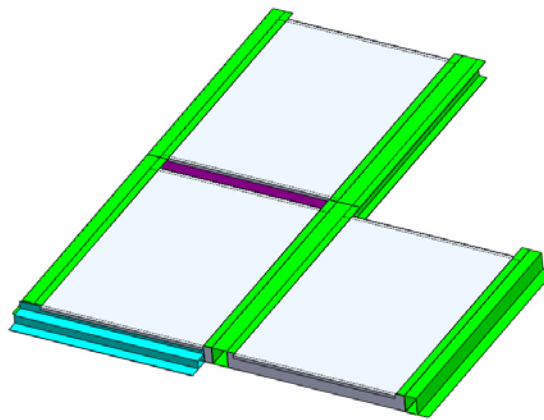

Figure 47: Joining system of concept *Traditional*

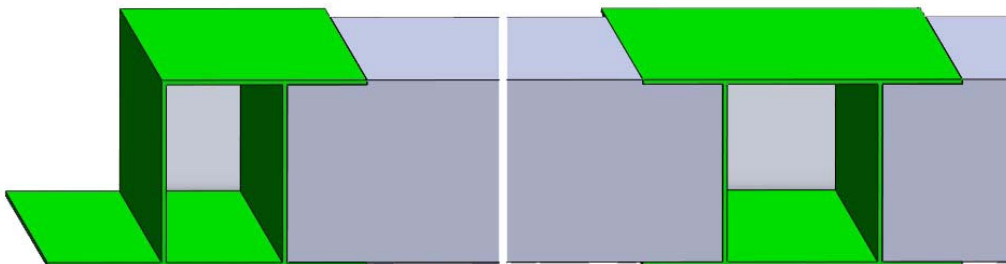

Figure 48: Horizontal (cross-section) of joining system for concept *Traditional*

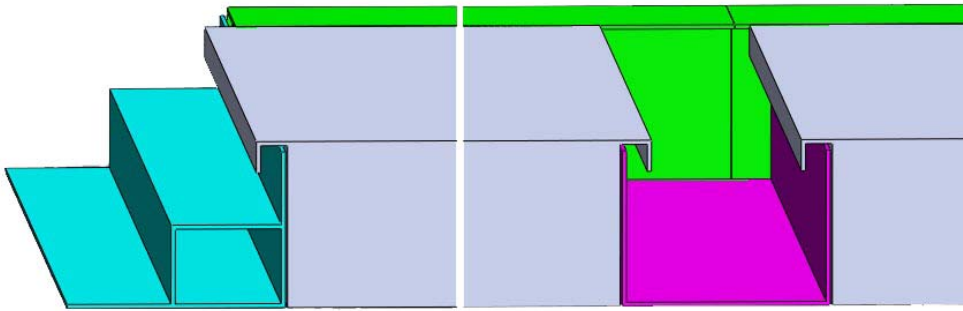

Figure 49: Vertical (cross-section) of joining system for concept *Traditional*

The advantages of the concept *Traditional* are the tried and tested technology and the high thermal and electrical yield. The main disadvantages are the high weight and costs of the panels. Besides, there is a relatively large amount of extra tubes needed outside the panels to connect them.

8.2. Concept *Plastic*

The focus of the concept *Plastic* is to lower the costs while remaining a good performance. An easier installation – caused by among others a lower weight – should contribute to reach this goal.

The cross-section of the inside of the panel is depicted in Figure 50. The panel consists of a plastic channel absorber (e.g. polyethylene). A PV laminate is glued on top of the absorber. Preferably, the PV is laminated with a plastic instead of glass to reduce the weight. Thin film roll-to-roll PV may be a good option for this concept, due to its light weight and good temperature resistance compared to crystalline silicon. The panel is covered by a layer of plastic to reduce thermal losses.

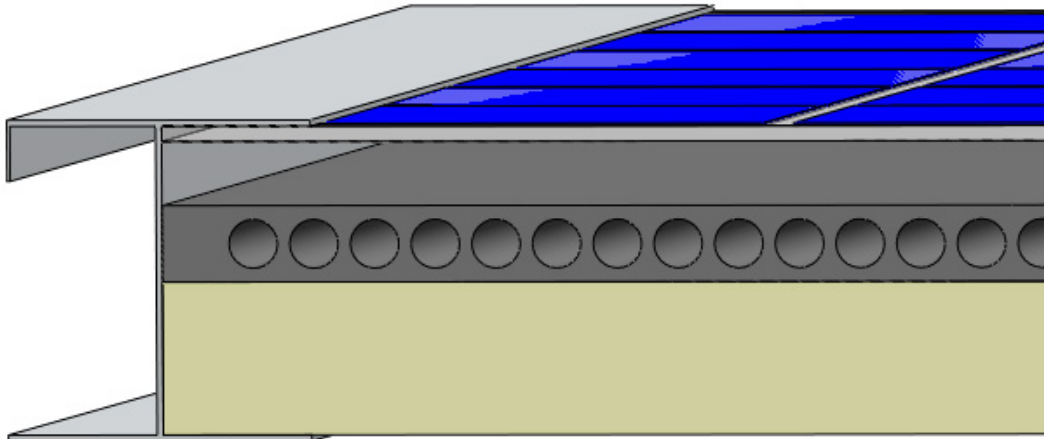

Figure 50: Cross-section of concept *Plastic*

The main advantages of using plastics are a low density and the complex shapes that can be made. Disadvantages of using plastics are a low temperature and UV resistance compared to conventional solar panel materials.

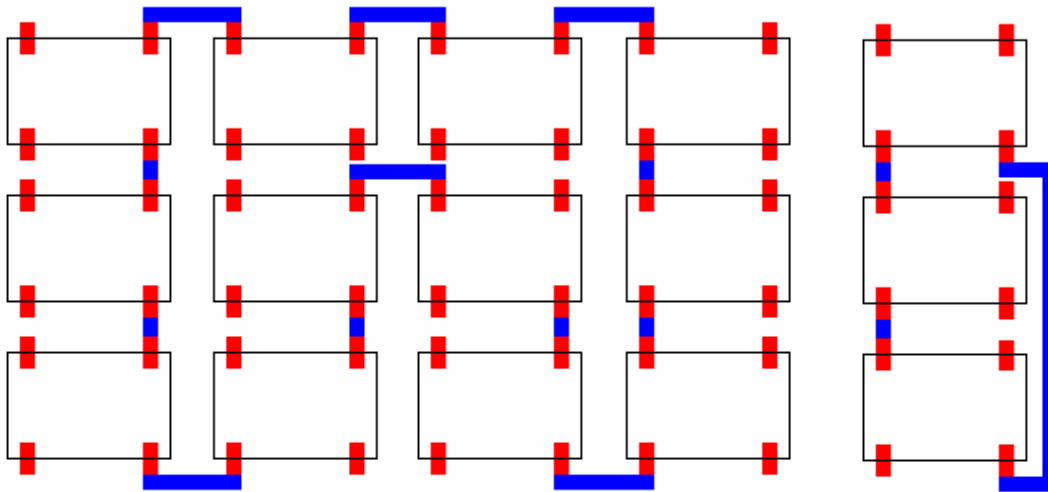

Figure 51: Connecting the panels of concept *Plastic*

In this concept each panel has four connection points positioned at two opposing sides. For each configuration of panels, a flow diagram is available which shows how the panels must be connected and therefore which connection points must be used. Using four connection points enables the use of only two types of connection tubes (assuming all panels to be equally apart): a straight tube and a U-shaped tube. This is illustrated in Figure 51. Only in the case where a single row or column is connected the standard parts can not be used, which is shown at the right of Figure 51. The standard connection parts can easily be clicked onto the panels, making it a plug-and-play system.

Figure 52 shows the joining system of the panels, which is a variation on the broadened I-profiles shown in section 7.2. The advantage of this new variation is that the joining system is not visible on the top sides of the panels. Because of that, the top sides look very smooth. The joining rails (yellow) are attached to the roof, after which the panels (grey) can easily be slid to their position. The joining rail can also function as gutter to drain the rain water. Perpendicular to the joining rails, the panels are separated by the standard connection parts (red). Figure 53 shows in more detail how the panels are connected to the joining rails and the standard connection parts. It also shows one connection point of the panel (green) that is not used in this situation.

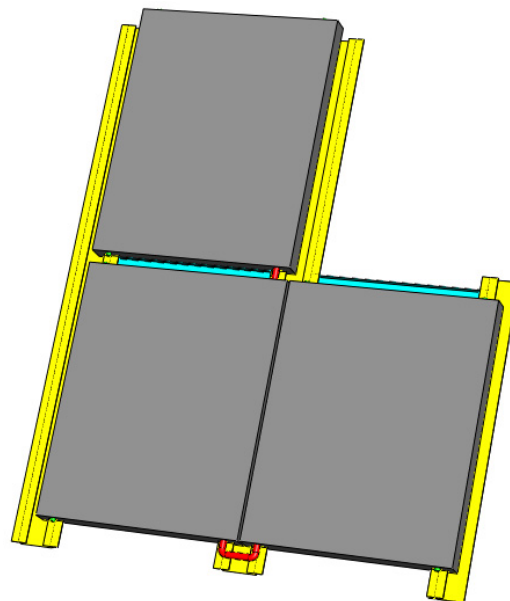

Figure 52: Joining system of concept *Plastic*

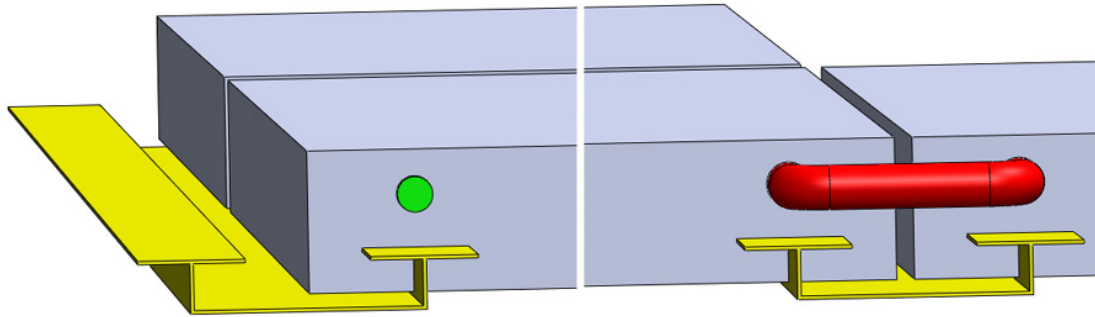

Figure 53: Cross-section of the joining system of concept *Plastic*

Comparing the simulated performances of this concept (set F in Table 6Table 5) to the performances of concept *Traditional*, it appears that they are very close together. However, the weight of the concept *Plastic* is only about two third of the weight of the concept *Traditional*.

The advantages of the concept *Plastic* are an easy installation, caused by standard connection parts and a low weight of the panels. There is much flexibility in the way the panels are joined, and the amount of extra tubes needed outside the panels is very small. The disadvantages of this concept are the material properties of the plastic. The plastics used must be able to withstand weather conditions and high temperatures inside the panel. The use of the four connection points could be a problem if the installation process is not designed well.

8.3. Concept *Skylight*

The focus of the concept *Skylight* is building integration. For acceptance of solar panels by architects and house-owners this is one of the most important issues.

The panels are executed as skylights to integrate them ideally into the roof. Skylights are commonly accepted parts of a roof construction and are often used to lighten the attic. Combining this function with the generation of energy may be a perfect way of integration. Figure 55 shows an example of a solar skylight.

Existing skylights of VELUX [56] are used as a source of inspiration for the solar skylights. The panels consist of a glass layer, some very thin insulation material, plastic channel absorbers, and a PV-glass laminate on top, as shown in Figure 54. The insulation, absorber, and PV cells only cover part of the panel. The rest of the panel looks just like regular insulated glazing.

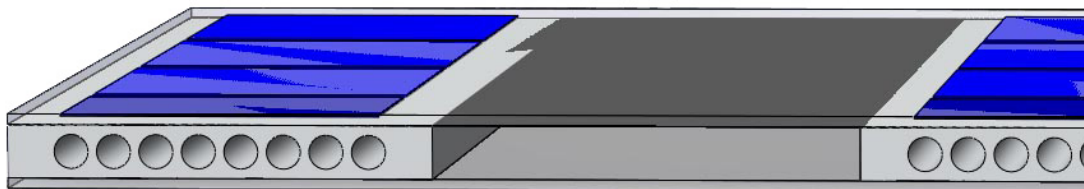

Figure 54: Working principle of concept *Skylight*

It is advisable – thought not necessary – to develop the solar skylight in corporation with VELUX. Their existing parts for the casing of the panels and for the gutters can be used. VELUX is chosen for a possible corporation, since they delivered about 80% of the skylights in the Netherlands. Besides, architects, contractors, and roofers are familiar with the VELUX system, which will help to get the solar skylight in the market.

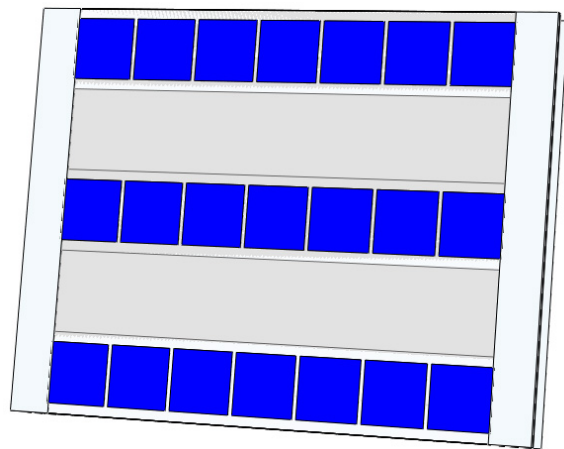

Figure 55: Concept *Skylight* is partly covered with PVT

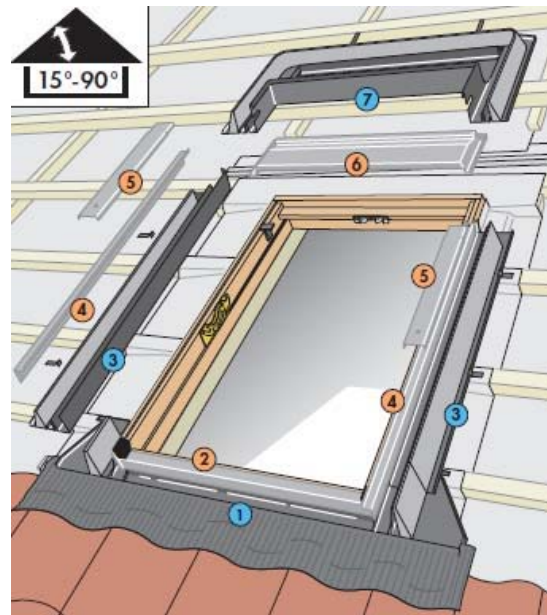

Figure 56: VELUX installation system [57]

The gutter system of the VELUX skylights is depicted in Figure 56. The skylights can generally be installed from inside the building, since all sides are well reachable. This is an advantage compared to other solar systems, since the time the installer has to spend on the roof is reduced to a minimum. When the entire framework is placed, the window can be clicked into the frame from the inside of the building. Like the regular VELUX skylights, it is possible to integrate several skylights next to or above each other.

The two connection points of the solar skylight are integrated in the hinges of the skylight. The working fluid from the different absorbers in one panel is collected in the middle of the window. Since part of the skylight is transparent, it may be an option to show the working principle of the energy generation, for example by showing the water flow in the absorbers.

The skylight is an uncovered panel and will therefore have a lower thermal yield than the other concepts. This can also be seen from the simulations (type E in Table 6). In reality, the thermal yield of the skylight will be even less, since there are many side effects where heat will be lost. These side effects are not taken into account within the simulations. Also the extra building losses are not taken along.

Given that only about half of the skylight will be filled with PVT, the thermal and electrical efficiency per m^2 will be rather low. Since there can only be a limited number of skylight panels on the roof, due to construction reasons, it will not be possible to cover (almost) the entire energy demand of a building. However, the building integration is very high and the skylight panels do generate a significant amount of energy, so this concept may still be an interesting option.

The solar skylight could also very well be accomplished with only PV. Flexible PV may be used as a kind of sunblind, which is turned to the sun when its intensity is at the highest. Also (semi)transparent PV will have good options to be used in solar skylights. It may be nice to further investigate these options in a future research.

The advantages of the solar skylight concept are its very good building integration and the minimisation of time the installer has to spend on the roof. The disadvantages include the low yield of the system and the dependence on corporation with VELUX or another skylight manufacturer.

8.4. Concept choice

Only one of the three concepts described will be further developed. To decide which concept shows the best potential to fulfil the requirements set, a multi criteria analysis is performed.

It is not possible to test the concepts against every demand in the program of requirements. Therefore, different themes are selected from the program of requirements: these themes are performance, building integration, and installation. Each theme is divided into several topics. For every topic a concept receives a score between one and five, where a five means the topic is fulfilled very well and one means it is not. The scores are based on how well the concepts are expected to perform on the given topic. Table 7 shows the given scores.

Next, weighting factors have to be assigned to the different topics. This is done in two steps. First, the weighting factors for the themes are determined. Second, the weighting factors within each theme are set. This two-step assignment of the weighting factors prevents a too large contribution of themes with many topics compared to the themes with fewer ones. The final weighting factor for each topic is obtained by the following calculation:

$$\frac{\text{Weighting factor topic}}{\sum \text{Weighting factors topics within one theme}} \cdot \text{Weighting factor theme} \quad (22)$$

The performance of the concepts has been set at a low importance, since the objective of this thesis is to focus on other aspects. However, the performance aspects can not be neglected, since they are the main reason why customers buy the solar panels. However, within this thesis, the driving force to select a certain concept is more influenced by the level of building integration and the ease of installation than by the performance.

Building integration is set to a slightly higher importance than installation, since building integration involves a significantly longer part of the life cycle of the panel. Besides, building integration involves the charisma of the building itself, but also of the surroundings, and can therefore be a decision making point in the question if a project will or will not be accomplished with solar panels.

When the weighting factors and scores for all topics are determined, they are multiplied and summed to get the overall score. The complete multi criteria analysis can be found in Table 7 on the next page.

Within the theme performance, concept *Traditional* scores best. Concept *Skylight* scores best within the theme building integration and concept *Plastics* within the installation theme. This should be no surprise, since these are the focus points of the different topics. Overall, concept *Plastics* scores the best, followed by concept *Skylight*.

Multi criteria analysis is a good tool to understand and motivate why a certain concept appears to be better than the others. However, setting weighting factors and giving scores is a subjective task. To see what the influence is of the chosen settings, a small sensitivity analysis is performed. Some questionable scores have been varied and the weighting factors of the themes have been changed to see if the final result changes. It turns out that – within small variations – concept *Plastic* always gets the best score.

Table 7: Multi criteria analyses

		Concept Traditional		Concept Plastics		Concept Skylight	
		Score	Weighted	Score	Weighted	Score	Weighted
Performance							
	2						
Thermal efficiency	2	4	1,3	4	1,3	2	0,7
Electrical efficiency	3	4	2,0	3	1,5	5	2,5
Total yield / m2	4	5	3,3	4	2,7	1	0,7
Costs	1	0,2	3	0,5	4	0,7	0,8
Manufacturing	2	0,3	1,3	4	1,3	1	0,3
	12					8,5	7,5
							5,0
Building integration							
	5						
Flexibility in dimensions	3	1,5	4,5	4	6,0	2	3,0
Charsima	4	2,0	6,0	3	6,0	4	8,0
Changeover between panels	2	1,0	2,0	2	2,0	4	4,0
Combine with skylight	1	0,5	1,0	3	1,5	5	2,5
	10					13,5	15,5
							17,5
Installation							
	4						
Ease of installation	4	2,0	4,0	4	8,0	5	10,0
Dimensions panel	1	0,5	2,0	4	2,0	3	1,5
Weight	1	0,5	0,5	3	1,5	4	2,0
Number of panels possible	2	1,0	4,0	5	5,0	1	1,0
	8					16,5	14,5
Total			32,5		39,5		37,0

9. Detailed design

In this chapter, the concept *Plastic* will be refined and expanded into a detailed design for the prototyping stage. First an overview of the detailed design will be given, including a review of the different components. Next the most important design considerations which led to the detailed design will be discussed in more details.

9.1. Construction of the panel

The detailed design of the PVT panel is depicted in Figure 57. Compared to the concept *Plastic* – as described in section 8.2 – the most important differences can be seen in the joining system, which is changed to guarantee the roof is waterproof. To get inside into the construction of the panel, first the different components will be described, after which the installation process will be discussed.

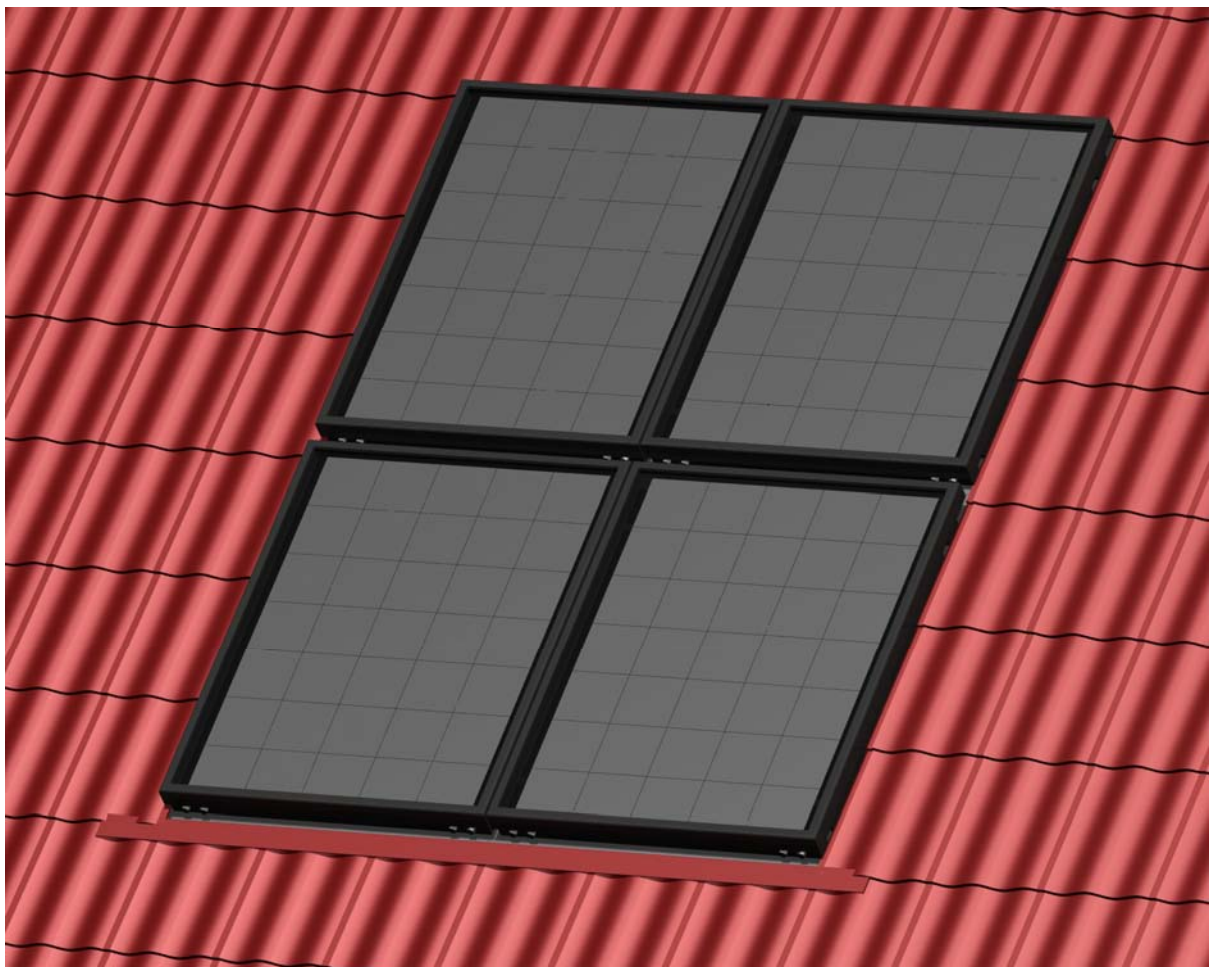

Figure 57: Detailed design of the PVT panel

9.1.1. Components of the panel

The different components of the panel can be seen in the exploded view in Figure 58. Top down the components shown are the covering, PV laminate, absorber, insulation, casing, and waterproof plate. Also the different connection points are shown. All components will shortly be described.

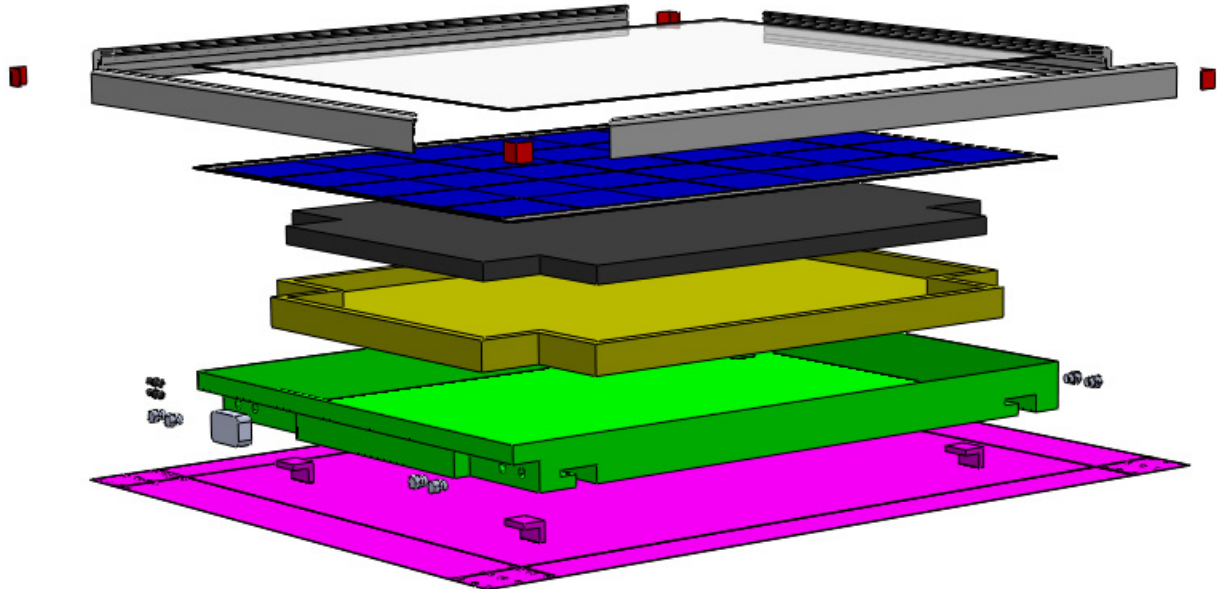

Figure 58: Exploded view

Casing

The casing is the body of the panel. It contains all other components and provides the joining for the thermal and electrical connection points and the joining with the roof. The casing gives the panel strength and makes it waterproof. On the top side of the casing some extra space is created for the thermal and electrical installation. The dimensions of the casing are 895 x 1150 mm².

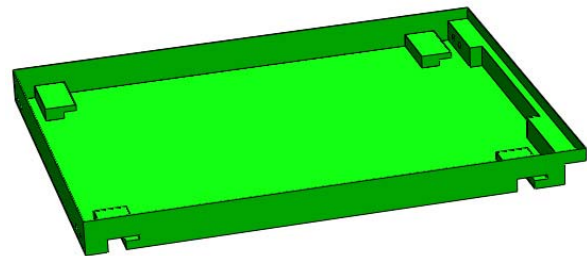

Figure 59: Casing

The casing will be made by hot-press or injection moulding. The holes are drilled in the casing in a next manufacturing step.

Insulation

To reduce heat losses, insulation is used on the sides and bottom of the panel. Depending on the design of the absorber, the heat losses can be determined. For now, 20 mm of insulation material is assumed, which is a little less than the 50 mm of regular thermal collectors. Therefore a better insulating and therefore – probably – more expensive material must be used, for example like Triso-Super 9+ [58]. Since the costs of the PVT panel are mainly determined by the costs of the PV laminate, a small increase in costs for the insulation will only have a small effect.

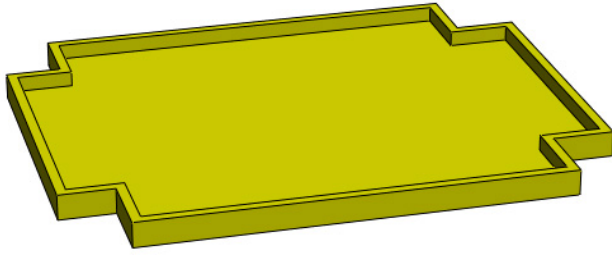

Figure 60: Insulation

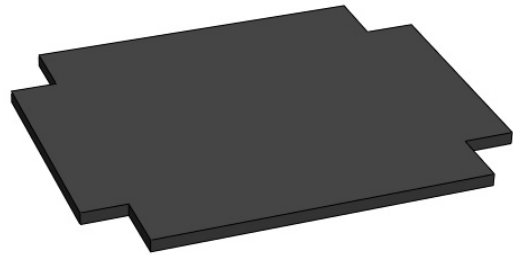

Figure 61: Absorber

Absorber

The channel absorber is made of a heat and UV-resistant plastic – e.g. polyphenylenoxid – and will be extruded or injection moulded, depending on the exact design of the absorber. The design of the flow pattern inside the panels is beyond the scope of this project. Yet, the boundary conditions resulting from the connections with the other components are determined.

Solarnor [59] is a commercially available channel absorber which may be used as an example of how the water is guided from one large flow to many very small flows and back to one large flow again. An important aspect to keep in mind is that a panel has four connection points of which only two are used. The water should flow through the entire panel, in spite of which connection points are being used. Figure 62 shows an example of how this may be realised. As indicated before, the exact flow pattern and absorber design will have to be determined in a future research. For now an absorber thickness of 30 mm is assumed.

Since a plastic channel absorber is used, the system can not be used under (high) pressure, since this will lead to deformations in the thin absorber walls. Due to manner the panels will be connected to each other, it is also not possible to use a drain back system, since some water can not be drained back and will remain in the panels. Therefore, the fluid in the panels will be used under atmospheric pressure. A glycol-water mixture will be used to prevent freezing and boiling of the working fluid.

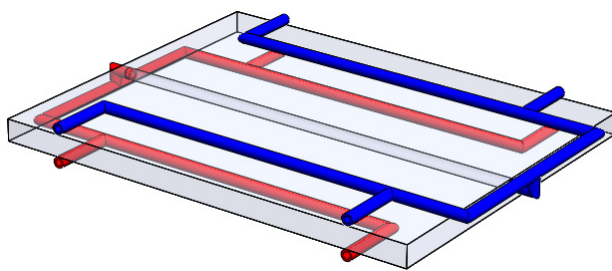

Figure 62: Absorber with 4x2 connection points

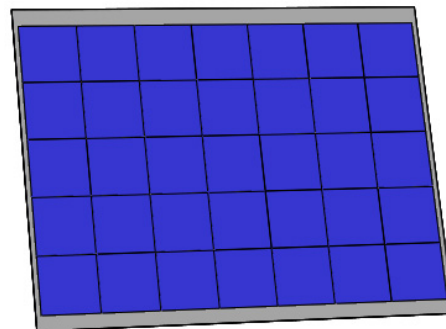

Figure 63: PV laminate

PV laminate

The PV laminate consists of 7 x 5 crystalline silicon PV cells of 156 x 156 mm². All cells are connected in series. The cells used in the SUNTECH module STP200-18/Ub [60] are used as reference cells to determine the performance of the PVT panel. The characteristics of these cells are listed in Appendix G. The output of the PV laminate will be about 8 A, 17 V, and 140 W_p. For a good heat transport between the PV laminate and the absorber, both parts are glued together.

The PV cells are placed 1 mm apart and laminated in glass like regular PV modules. Although the glass contributes largely to the weight of the panel, for the time being there seems to be no better, commercially available alternative. For the future, thin film PV

cells may be used, like amorphous silicon cells. The laminate does not need to be flexible, but replacing the glass by a plastic will significantly reduce the weight of the panel. Another possibility for the future is to use crystalline silicon cells laminated in a glass-fibre-reinforced composite. Also the new, larger PV cells can be used in the panel. Using 5 x 4 of these new cells of 210 x 210 mm² increases the PV area with 3.5%. However, these cells are not commercially available yet.

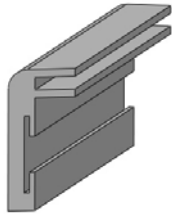

Figure 64: Covering profile

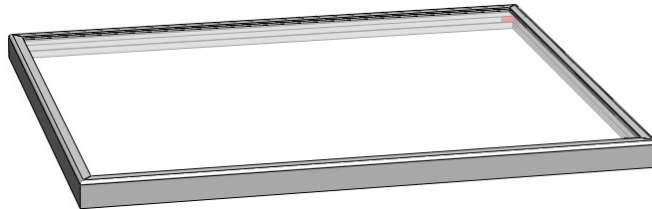

Figure 65: Covering

Covering

The covering of the panels consists of a transparent plastic layer clamped in between four profiles. The profiles exist of extruded plastic – e.g. polycarbonate with a UV protecting front cover – which is sawed to the right dimensions. Small plastic hooks are used to connect the profiles perpendicular. To assure the panel is waterproof the edges between the profiles and the plastic layer are sealed with a UV-resistant sealant. To close the panel the covering is screwed onto the frame from the sides.

The air layer between the plastic layer of the covering and the PV laminate is 30 mm. As can be seen in Figure 66, the optimal air layer thickness is about 12 mm. If the air layer is thicker the heat losses remain almost the same, but if the air layer is just slightly smaller, the heat losses increase significantly. To be on the safe side – taking uncertainties like manufacturing into account – the air layer is taken at 30 mm.

Joining plate

The panels are placed on waterproof plates which are joined on the roof. This joining system differs from the joining system shown at the concept design. Section 9.2 will explain why the joining system has changed. The joining plates are placed overlapping on the roof to create a waterproof layer. The plates are equipped with hooks facing upwards where the panels are easily slid on to. This system has similarities with the Intersole system [38;62] as described in section 3.3. However, the Intersole system is meant to make a waterproof layer where all types of PV modules can be placed on, while the joining plates are specifically meant for the PVT and PV panels designed within this thesis and not for other modules.

Flexibility in dimensions is realised by overlapping plates. If the plates overlap less, the panels are further apart and may better join the dimensions of the roof tiles.

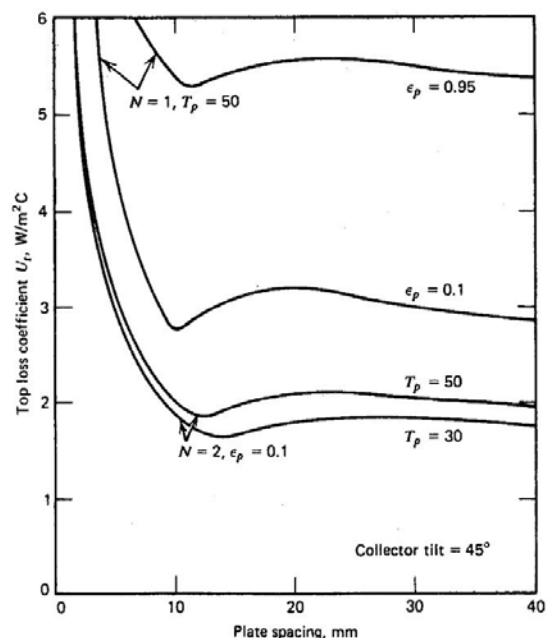

Figure 66: Insulation value of the air layer [61]

The joining plates are made of a UV-resistant plastic using hot-pressing. Special slots can be made in the plates for good water drainage and to make the panels overlap nicely. The Intersole plates may be used as inspiration for the detailed design of the plates. The hooks will be fastened with screws on the plates. The joining plates have no holes for

fastening to the roof, since the position of the tile laths will differ significantly between roofs. Instead, self-tapping screws with waterproof rings will be used to fasten the plates to the roof.

The changeover between the panels and the roof tiles is smooth on the top and sides of the panel. On the bottom of the panel a split can be seen between the panel and the roof tiles. This is also the case at the side when a panel is placed next to a skylight. To remove this split, the plates at these positions can be cut along the lines indicated at the panels. By removing part of the plates, the roof tiles can be placed closer to the panels.

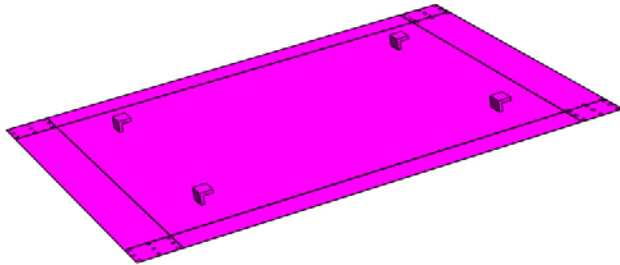

Figure 67: Joining plate



Figure 68: Ubiflex material [63]

Ubiflex

Ubiflex will be used to guarantee a waterproof changeover between the plates and the roof tiles or skylight, also under more extreme conditions. Ubiflex [63] is a watertight building material, which is light-weight, easy to use, and friendly to the environment (unlike lead, which was formerly used). It is supplied on rolls of 500 mm width and 12 m length. It can easily be cut to the right size with regular roofer tools. For aesthetical reasons the Ubiflex preferably matches the colour of the roof tiles. The way Ubiflex is used at the installation is described in the next section.

Thermal connections

The thermal connection points are positioned at each corner of the panel. To join with the absorber each connection point exists of two points: one for the water inflow and one for the water outflow. The inlet and outlet points are positioned next to each other to keep the thickness of the panel as small as possible. The *inlet* is always positioned on the *inside* of the panel, while the *outlet* of the panels is always positioned on the *outside*, as shown in Figure 69. To prevent confusion the end caps at the connection points will also be labelled *IN* and *OUT*. Furthermore, only male connectors can be connected to the inlets, while only female connectors can be connected to the outlets. This also prevents the connection of inlet-to-inlet or outlet-to-outlet.

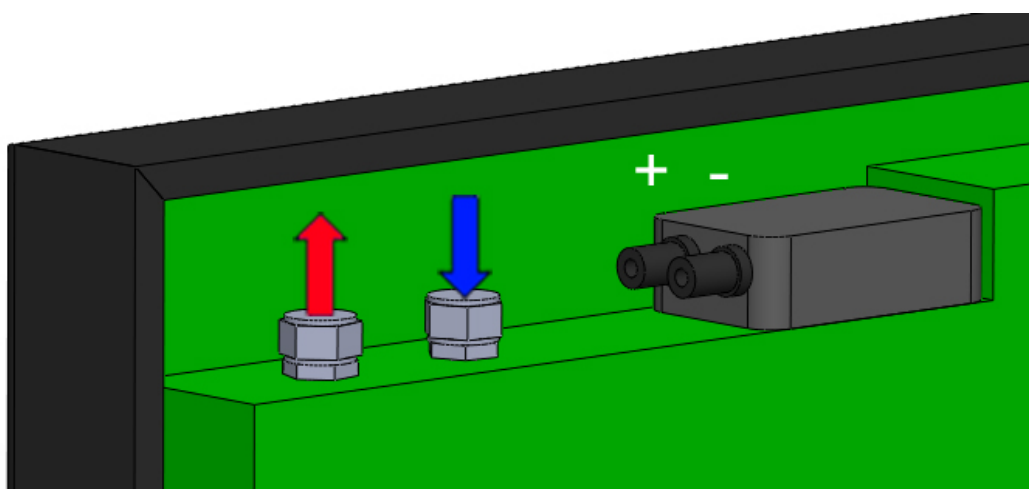

Figure 69: Thermal and electrical connection points

To meet the flexibility in dimensions cause by the overlapping of the joining plates, flexible connections will be used to thermally connect the panels. This will be done using standard tube fittings like compression fittings and press fittings, as depicted in Figure 70. When using press fittings no tools are needed, which makes the installation easier and faster. On the other side, compression fittings are smaller, so the panels can be placed closer together. Due to aesthetical reasons, compression fittings fixed at insulated flexible plastic tubes will be used, as shown in Figure 71. The tubes have a diameter of 15 mm and a male and female connector.



Figure 70: Press fitting (left) and compression fitting (right)

When the panels are placed on the roof, all connection points are closed by tube fitting end caps. The end caps are removed after the panels are fixed on the roof, to prevent damage of the connection points. From the connection points that will be used to connect the panels, the end caps are removed and replaced by the compression fitting fixed at the flexible tube. For the loosening of the end caps and the fastening of the compression fittings a standard adjustable-joint pliers can be used. It is important that the compression fittings get connected well, to prevent leakages.



Figure 71: Thermal connector and flexible plastic tube

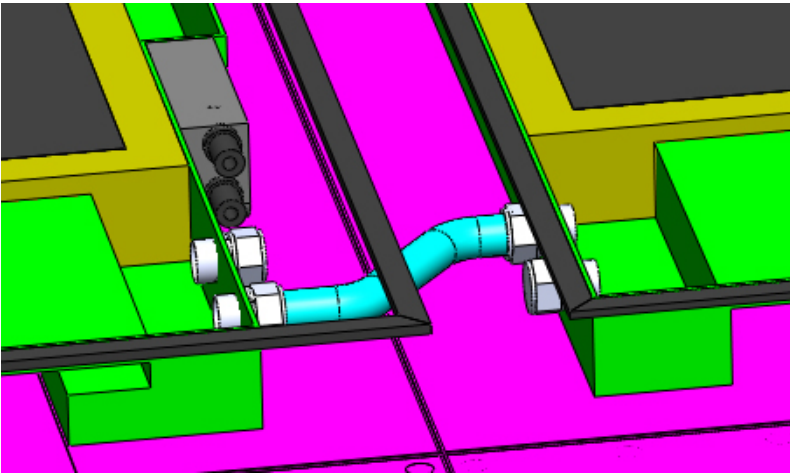

Figure 72: Close-up of the thermal connection between the panels

Electrical connections

Depending on the number of panels and their positioning the panels will be connected electrically both parallel and in series. Figure 73 shows a possible electrical flow diagram for six panels, with three parallel strings of two serial connected panels. Notice that the electrical and thermal flow diagrams do not have to be the same.

The junction box – see Figure 75 – is 50 x 80 mm and positioned on the top side of the panel, as shown in Figure 69. Standard PV cabling will be used to electrically connect the panels via the junction box. The position of the electrical connection points is easy accessible, prevents kinks in the cables and makes the cables (almost) invisible from the ground. The cables have a length of 1400 mm or 1100 mm, depending on the direction of the cable (lengthways or widthways along the panels).

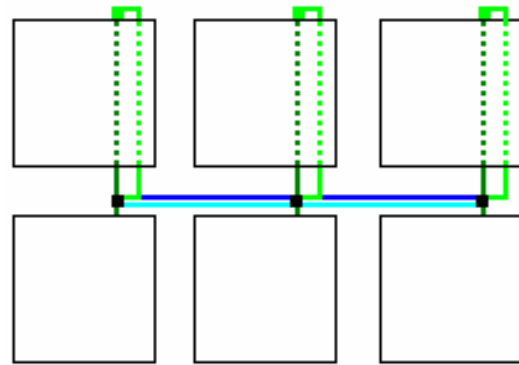

Figure 73: Possible electrical flow diagram for 3 x 2 panels



Figure 74: PV cables and couplers



Figure 75: Junction box of Multi-Contact

9.1.2. Installation

The installation process is split into two parts. A roofer will place the waterproof plates and is responsible for making the roof waterproof. A thermal installer will place the panels on the roof and make the thermal and electrical connections, both on the roof and inside the house.

Table 8 schematically shows the installation process. The first three steps are performed by the roofer; the further steps are performed by the thermal installer. Preferably the placement of the roof tiles at the final step will be done by a roofer, but this can also be done by the installer.

An accurate positioning of the first joining plate is necessary for the system to be properly installed, since all other plates and panels are positioned according to this first one. Next plates can easily be positioned by placing their sides to the clips of an earlier plate. The tolerances in the roof tiles dimensions can be met by overlapping the joining plates a little less. The plates should however overlap at least 190 mm to keep the construction waterproof. Since the difference in overlapping is not more than a few cm to match the

roof tiles, the plates will always overlap sufficiently. Once the plates are positioned correctly, the panels will always be positioned well.

The first joining plate has a round hole in the right top corner to make the connections through the roof. Once the first row of panels is placed, the electrical cables and the thermal flexible tubes can be put through this hole to get inside the house. If the panels are not directly placed on the joining plates, the hole in the first panel can be covered by a cap which makes the panel waterproof.

Compared to the installation of the reference panels, the new installation process is expected to be faster and less burdening for the installer. Due to the low weight and ergonomic dimensions of the plates they can be positioned easily and precise. It is possible to shove the plates over the tile laths to the right position. The panels – which are lighter than the reference panels – do not have to be positioned in a precise manner, since they are simply guided by the plates. The weight and dimensions of the panels make it possible for one person to do the lifting and installation.

The new panels are especially designed to connect multiple panels on a roof. To create flexibility in the numbers and positions of the panels, it is inevitable that the installer will have to make connections between the different panels. Due to the standardisation use within the design, this will be a simple task. Especially for larger areas – from 4 m² – the new panels are expected to be installed faster than the reference panels.

	<p>1. Prepare the roof by removing roof tiles. Place Ubiflex on an extra tile lath, placed 20 cm above a regular tile lath. Carefully determine the position of the first plate.</p>		<p>2. Place the waterproofing plates from left to right and from bottom to top. Fasten them with screws. The edges of a new plate should be placed against the clips of the plates which are already placed.</p>		<p>3. Place Ubiflex on the sides and top of the panels. If the panels will not be installed directly, the roof tiles around the plates can be placed back to make the roof waterproof.</p>	 <p>(Top covering is removed for better visibility)</p>	<p>5. On the top side of the panels, the thermal and electrical connections are made as far as possible. The electrical cables can be</p>		<p>4. Slide the bottom row of panels onto the waterproofing plates.</p>		<p>6. The next row of panels is slid on the waterproofing plates.</p>	 <p>(Top covering is removed for better visibility)</p>	<p>7. The thermal and electrical connections between the top of the first row and the bottom of the second row of panels can now be completed.</p>		<p>8. Repeat step 5 to 7 if needed. When all panels are placed and connected, the roof tiles can be put back to their position.</p>
---	--	---	--	--	--	---	---	---	---	--	---	--	--	---	---

Table 8 • Installation process

9.2. Design considerations

This section describes some of the major design considerations that have been made. These considerations mainly include the joining system and the dimensions of the panels.

9.2.1. Joining system

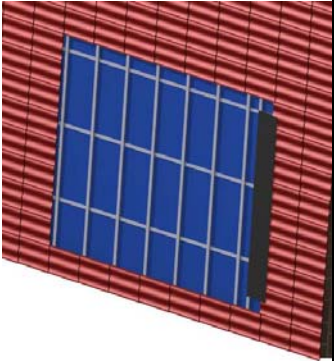
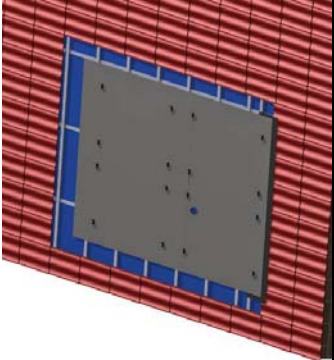
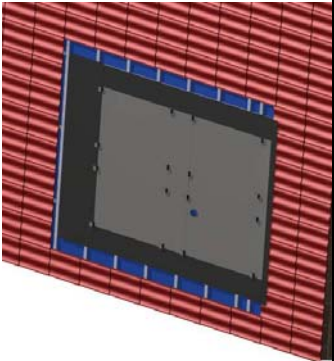
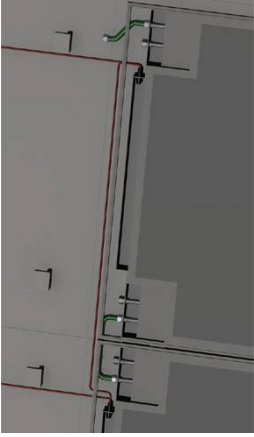
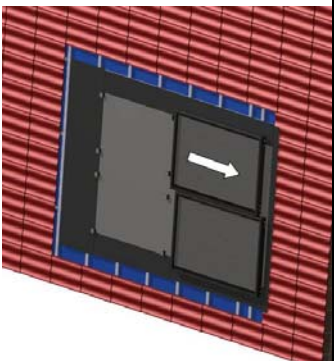
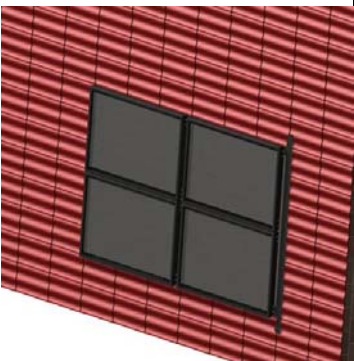
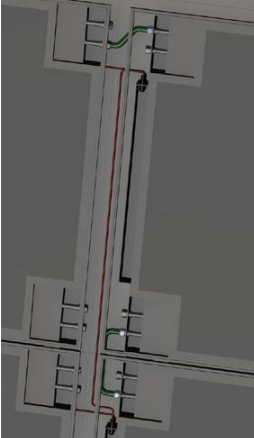
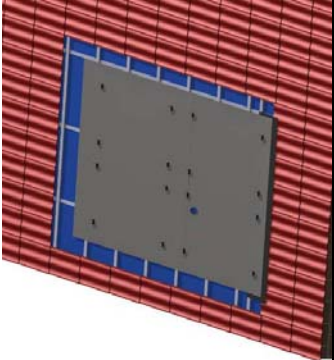
In the concept *Plastic* the joining system existed of rails where the panels could be slid over. The connections and water drainage in one direction is thereby determined. In the other direction there are different possibilities, as can be seen in Figure 76 and Figure 77. In Figure 76 after each panel a simple U profiled gutter (blue) is slid in the rails. Although this seems to be a watertight construction, the water can not be drained. Therefore, the gutter will slowly be filled with water and overflow, leading to water between the panels and the roof. Figure 77 shows a situation where the water from the gutters flows into the rails. Although the water is now drained, the construction is not waterproof since there are gaps between the rails, panels, and the gutters. This can be solved by using special connection parts (purple) between the vertical rails and the horizontal gutters, as is shown in Figure 78. The installation is now again more complex and time consuming, since there are many different parts which all have to be positioned and connected. Besides, it remains difficult to cover all gaps.

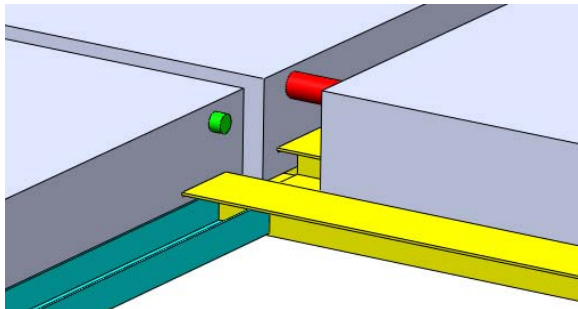

Figure 76: Joining system with U profile between rails

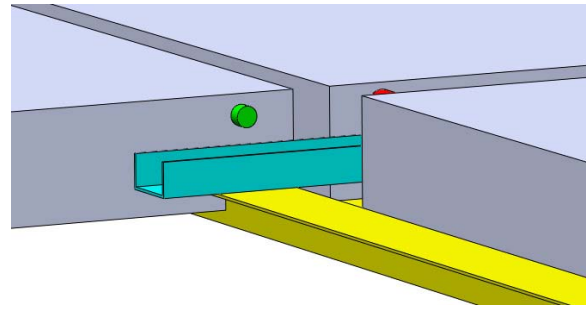

Figure 77: Joining system with U profile on top of rails

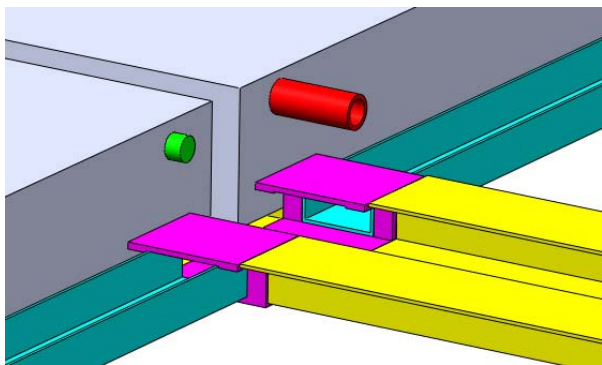

Figure 78: Connection part to connect the rails and gutters

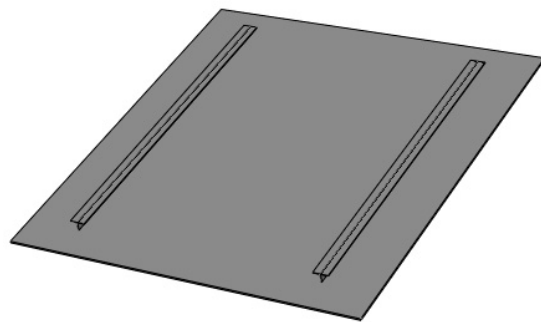

Figure 79: Plate with original rails

A simpler solution is to place the original joining system on waterproof sub-plates as shown in Figure 79. By using waterproof plates, the joining between the panels does not have to be waterproof anymore. Besides, within new construction or retrofit projects, the plates can be placed by a roofer at the same moment as the roof tiles, making the building watertight. The placement of the PVT panels can be done at a later stage, which is desirable looking at building planning and theft prevention. Considering the space needed to slide the panels over the rails and the manufacturing of both the panels and the plates, the rails are adapted to the configuration as was shown in Figure 67.

9.2.2. Dimensions

The panels have a surface of 895 x 1150 mm². These dimensions are influenced by different aspects like other dimensions on the roof, solar cell dimensions, and the installation process. The influence of the different aspects will shortly be described to show why these are the optimal dimensions for the panels.

The dimensions of the panels and the ease of installation are largely influenced by each other. From an installation point of view, the demands are conflicting: the panels should be large, looking at the amount of connections that have to be made, but they should also be small for easy lifting, carrying, and positioning. Besides, it is preferred that panels are placed in rows or columns of at least two panels to limit the amount of tubes outside the panels. Based on anthropometric analysis – see Appendix H – the maximum width of the panels for comfortably lifting is determined to be 1022 mm. Anthropometrics give no indication for the length of the panel.

Some space is needed to place the panels and to make the connections between the panels. Widthways 5 mm is needed, while lengthways 50 mm is needed to reach the connection points. In the end these values have to be distracted from the panel's length to come to the final dimensions.

The building sector is based on dimensions of 300 mm, but with a large tolerance. This can also be seen within the dimensions of different kinds of roof tiles, as was shown earlier in Table 4. The roof tiles have an average working width of 300 mm, but they also have about 20 mm tolerance due to overlapping. The large tolerances on the roof are met by the joining plates under the panels. If the roof tiles are placed further apart, so will the plates, creating some extra space between the panels. The advantage of meeting the tolerances in this way is that no large gaps arise at the changeover between the panels and the roof tiles at the sides.

Next to joining the dimensions of the roof tiles, the panels should also join the dimensions of skylights. Since VELUX owns about 80% of the Dutch market of skylights, their dimensions are used to be joined. Figure 80 shows the dimensions used by VELUX.

Combining the different aspects 900 mm will be a good choice for the width of the panels, including a 5 mm distance between the panels. To create more flexibility the panels can also be used when rotated 90°, which means that the length of the panels should also be a multiple of 300 mm. If the panel is a square, there is no use in rotating it. Since the panel may not be too small or too large from an installation point of view, 600 or 1200 mm are the possible dimensions for the length including a 50 mm distance between the panels.

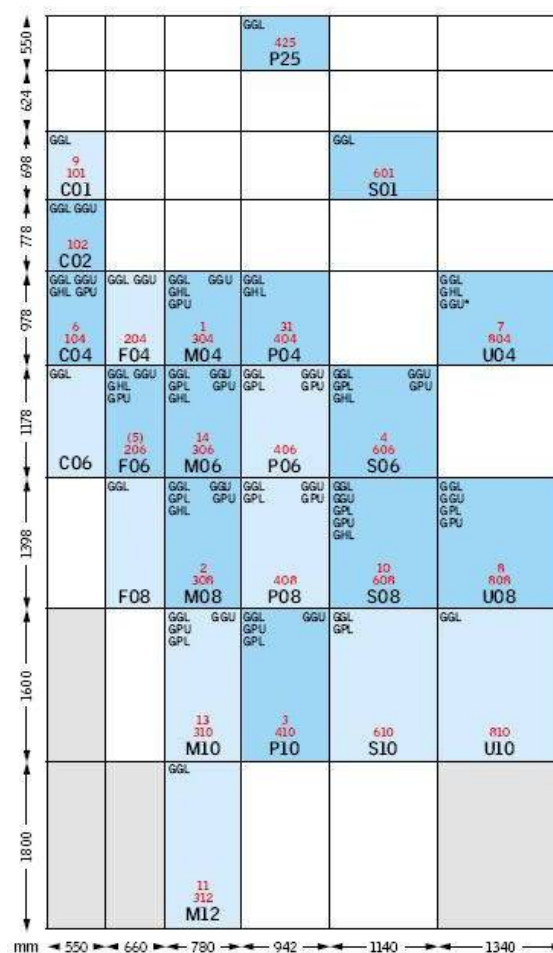

Figure 80: VELUX skylight dimensions [64]

PV modules often exist of 4 x 9 cells of 156 x 156 mm². For a high electrical yield, a high packing density (ratio between PV cell area and module area) is required. Figure 81 illustrates how the packing density of a panel changes depending on the distances between the cells and the width of the housing edges. Logically, the packing density is higher if the cells are placed close together and the housing edges are small. Since the packing density is linearly linked to the panel efficiency, it should be as high as possible.

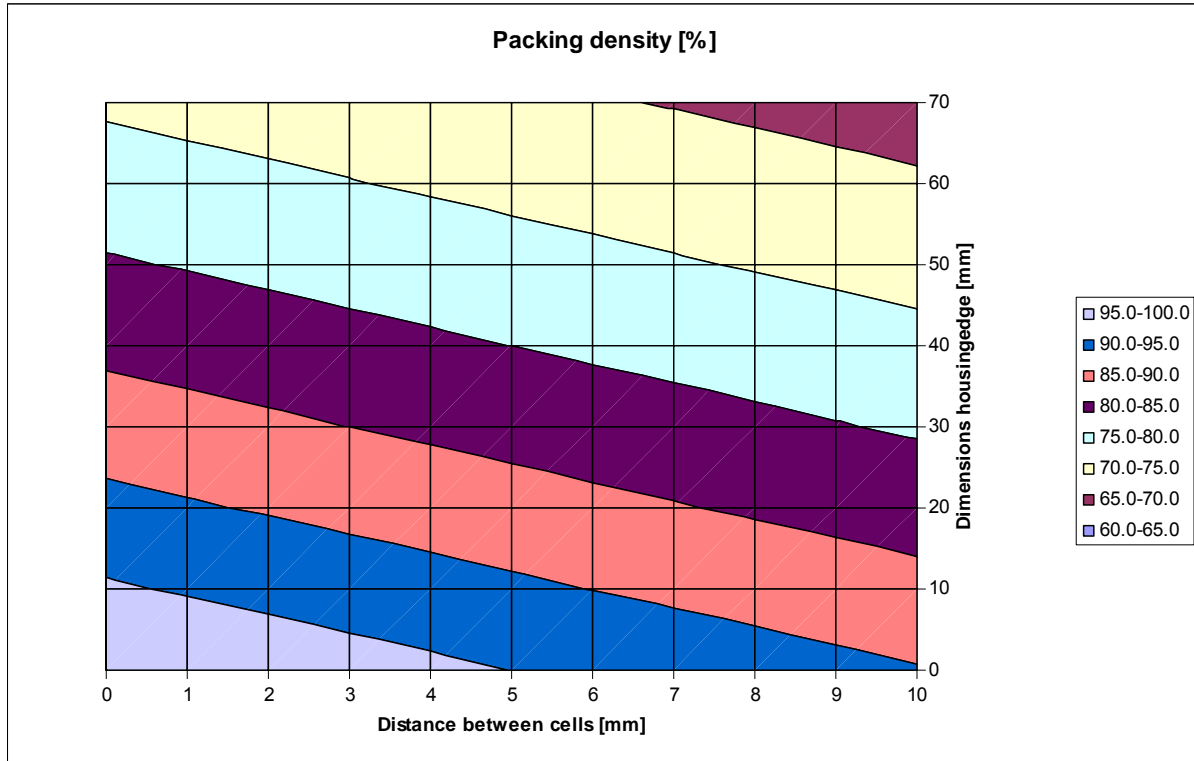

Figure 81: Packing density of a panel with 4 x 9 PV cells (15% efficient)

Table 9 shows how many cells can be placed in a length 600, 900, and 1200 mm. Besides, it reveals the length that can be used for spacing, including the distance between the cells, the space needed for the housing, and the distance between two panels. As can be seen in the width of the panel (900 mm) fit 5 cells of 156 mm while 120 mm is left for spacing (for example 5 mm between two panels, 15 mm between the cells and 50 mm for both edges). The table also shows that a doubling of the panel length from 600 to 1200 mm more than doubles the amount of cells. Therefore a panel length of 1200 mm has a higher packing density and is therefore favoured over the 600 mm length. Furthermore, the 5 x 7 = 35 cells of this panel almost equal the 36 cells of 'regular' PV modules, so that regular PV inverters can be used.

Table 9: Number of cells fitting in a panel (dimensions in mm)

Length of panel	600	900	1200
Number of cells	3	4	5
Total length of cells	468	624	780
Length left for spacing	132	120	108

As mentioned before, the space needed to make the connections still has to be deducted from the panel's dimensions. This means the panel will be 895 x 1150 mm², instead of 900 x 1200 mm². Thereby the length left for spacing is reduced to 115 mm widthways and 58 mm lengthways. Although 58 mm is quite small, it is possible to make the panels within these dimensions.

9.2.3. Number of panels

The number of panels that can be connected can be limited by the space available and by the thermal and electrical properties of the panels. Using the SenterNovem reference buildings [32] the row house and semidetached house of the have a roof area of respectively about 33 and 38 m² suitable for solar panels. The height of the roof is around 6.5 m, so – depending on the orientation of the panels – a maximum of five or seven panels can be placed above each other. Widthways of the roof four to six panels can be placed next to each other. Given that thermal collectors are often dimensioned at 50% of the hot water demand, three to six PVT panels will be sufficient. The PVT panels can further be extended with PV panels from the same product family, which have the same dimensions and charisma as the PVT panels.

Since the panels are thermally connected in series, the amount of panels to be connected is limited by the successive heating of the water and the pressure drop over the panels. The effect of successive heating can be influenced by keeping the residence time of the water in all panels constant, irrespective of the number of panels. Typical flow rates for thermal collectors are in the order of 50 l/h per m² collector area. The maximum flow rate will have to be determined in a future research.

Electrically, the panels will be connected both parallel and in series to fall within the ranges for current and voltage of the inverter. Since the number of panels is flexible, different inverters will be used for different situations.

Concluding, given the space available on a roof no limitations are expected concerning the amount of panels to be connected. The flow rate and inverter type are chosen matching to the number of panels. If it turns out that the flow rate will approach its maximum value when many panels are used, it is possible to divide the panels thermally into two parallel sets. However, as long as seasonal heat storage is not commercially available the amount of PVT panels used will likely be too little to approach the maximum flow rate.

9.2.4. Colouring

The actor analysis has clearly shown that dark colours like charcoal-grey are favourable for solar panels. Therefore, charcoal-grey will be the main colour of the panels. Both the housing and the covering frame will be finished in this colour. Also the waterproof plates will be coloured charcoal-grey, so they become almost invisible from the ground. The PV cells will be coloured dark as well.

Part III: Evaluation

“The best way to predict the future is to invent it” – Alan Kay

10. Product overview

This chapter gives an overview of the design of the PVT panels. First some overview pictures of the use of the panels will be given, followed by panel specifications. In the next section the design of the panel is evaluated with respect to the requirements stated in chapter 5. This chapter ends with an indication of the further steps that are needed to get the panels ready for market introduction.

10.1. Product presentation

Figure 82 shows the look of the panels and the waterproof plates. A cross-section view of the panel's construction is depicted in Figure 83. A more detailed description of the construction was given in section 9.1. Next to the PVT panels accompanying PV panels can be installed. For a uniform charisma the PV panels have the same housing and plastic covering as the PVT panels, but the insulation, absorber, and the thermal connection points are removed. Therefore, from the outside the PV panels look the same as the PVT panels. Extra ventilation holes in the casing prevent the PV cells from overheating.

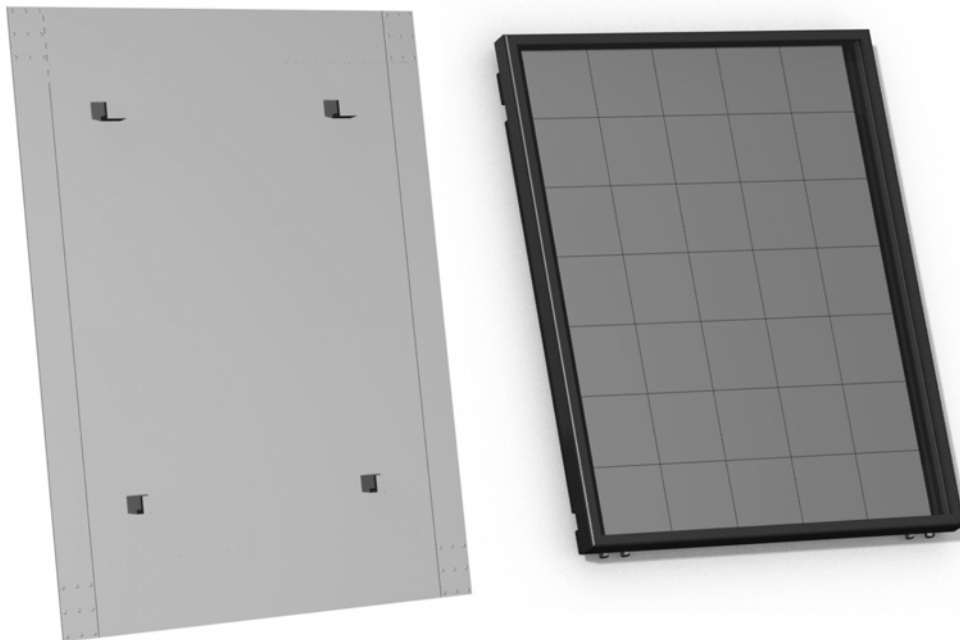

Figure 82: Final design of the panel and plate

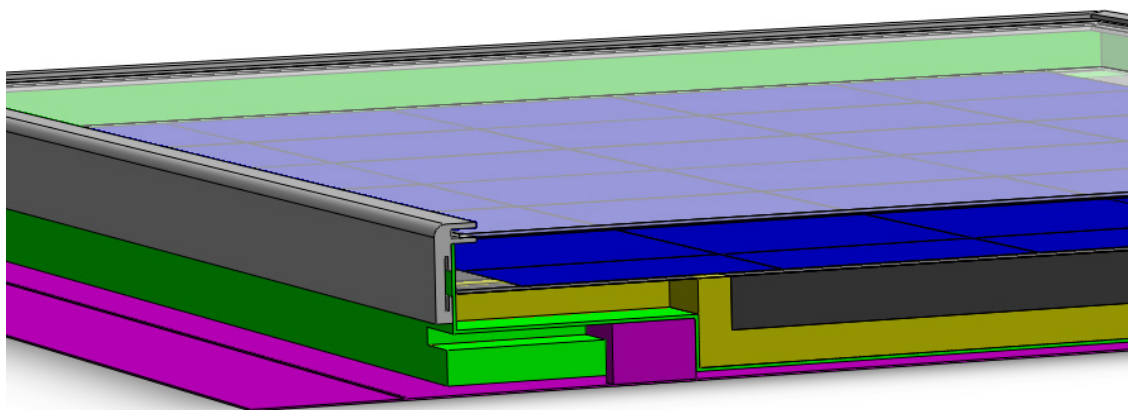

Figure 83: Cross-section of the panel and plate

Figure 84 shows what the panels may look like when installed on a semidetached house. Also the changeover between the panels and a dormer can be seen. Figure 85, Figure 86, and Figure 87 show the installed panels in more detail.



Figure 84: PVT panels on semidetached houses



Figure 85: Panels placed next to a dormer

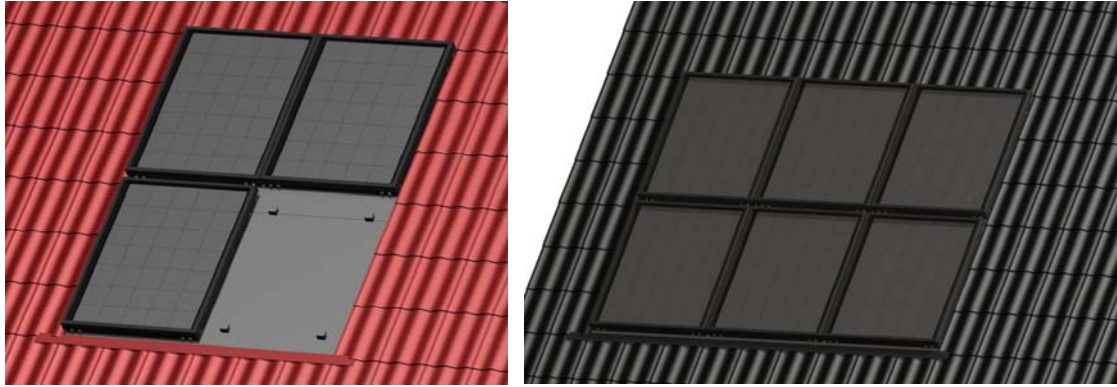

Figure 86: Panels installed on a roof with red and black roof tiles

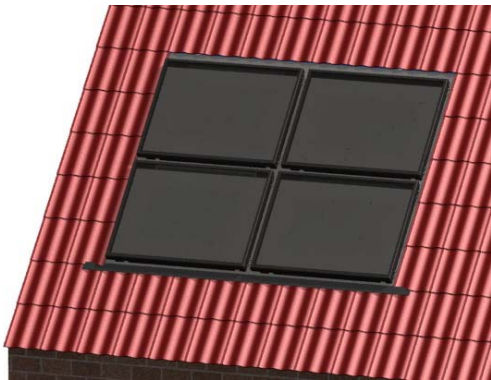

Figure 87: Panels positioned vertically

10.2. *Unique selling points*

What makes this design special, is the opportunity to use the panels in many different situations. The panels can be placed horizontal and vertical, and are flexible in dimensions caused by the overlapping of the plates. This causes a good joining and smooth changeovers with different dimensions on different roofs.

When solar energy becomes a commodity, the advantages of PVT compared to side-by-side systems become even more important. This design is prepared for the large scale use of solar energy, since the system can easily be adapted to future situations. If seasonal heat storage become available, the system can be extended with more PVT panels. Due to the possibility to combine PVT and PV panels of the same product family, the ratio between heat and electricity supply can always be tuned, while remaining a good aesthetical value of the building.

The installation of the panels is expected to be easier and faster than for the reference panels. This reduces the overall price to invest in solar panels. Within large building projects, the roof can be made waterproof in an early stage of the building process, while the panels can be placed shortly before the delivery of the buildings. Looking at vandalism and theft, this is an important improvement.

10.3. Specifications

The specifications of the panels are listed below. The expected performances are based on new simulations following the design choices made.

Dimensions

Panel	1150 x 895 x 80 mm (1.0 m ²)
Working dimensions	1200 x 900 mm
Waterproof plate	1460 x 1115 x 2 mm
Channel absorber	1036 x 831 x 30 mm
Weight panel	16 kg (unfilled)
Weight plate	1.6 kg

Electrical properties

Solar cells	Poly-crystalline 156 x 156 mm (6 inch)
No. of cells	35 (5x7)
Cell efficiency	15%
Operating cell efficiency	12.9 %
Maximum power (STC)	120 W _p
Operating voltage	17 V
Operating current	7 A

Thermal properties

Working fluid	Glycol
Flow rate	50 l/h/m ²
Tube diameter	15 mm
System pressure	Atmospheric

Performance (expected)

Electrical yield per panel	96 kWh/yr
Thermal yield per panel	0.95 GJ/yr = 265 kWh/yr
Panel cost	€400,- to €500,- (excl. installation and VAT)
Of which costs for PV cells	€350,-
Pay back time	~ 15 years

For the determination of the pay back time, the following assumptions are made:

Price of electricity	€0.22 / kWh
Price of gas	€0.67 / m ³
Conversion heat to gas	1 GJ ≡ 46 m ³
Total panel costs (incl. installation, VAT, operation and maintenance)	€750,-

Due to uncertainties, possible increasing energy prices are not taken into account, neither is the interest of the money if it would have been put on a banking account .

One panel has a yearly saving of €21,- of electricity and €29,- of gas used for heating. The total yearly savings are €50,- which results in a pay back time of 15 years.

10.4. Product evaluation

The focus of the design is on lowering costs. Although the costs of the panel are only slightly lower than for the reference panels, the installation costs are expected to be significantly reduced. This will be caused by shorter installation times, which are the result of an easier installation process and a better handling of the lightweight panels.

Table 10 shortly summarises the program of requirements as set in chapter 5, followed by an indication if the requirement is met. At the moment it can not be said if the requirements for construction and safety will be met. Although all requirements will have to be tested in practise, the table definitely shows that the expectations are good.

Table 10: Evaluation based on program of requirements

Primary functioning		
1.	Waterproof	++
2a.	Electrical output	++
2b.	Thermal output	-
2c.	Price	++

Context		
3.	Use in 2020	++
4.	Sloped roofs	++
5.	New construction and retrofit projects	++
6.	Different system sizes	++
7.	Combine with PV	++

Legislation and safety		
8-13.	Regulations and reliability	?

Building integration		
14.	Environment and building style	++
15.	Finishing	+
16.	Skylights and dormers	++
17.	Not hinder environment	+

Installation		
18.	Easy, clear, fast	+
19.	Arbo conditions, weight	++
20-21.	Connect to standards	++
22.	Single roof opening	+
23.	Shadowing	+
24.	Theft prevention	++

Manufacturing and storage		
25.	Mass-production	+
26.	Standard components	+
27.	Transport dimensions	++
28.	Building site conditions	+

Operation and maintenance		
29.	Life time	-
30.	Easy maintenance	+
31.	Monitoring	++

The panels meet the requirements for electrical output (minimum of 90 kWh/(m² yr)) and costs (maximum of €750,-/m²). The requirement for thermal output (minimum of 300 kWh/(m² yr)) is not met. Partly this is due to the fact that the absorber is only covering 86% of the complete panel.

The effects of using plastic in the panels will have to be researched in more detail. The plastics to be used must be highly UV-resistant or be supplied with a UV-resistant layer. For now it is difficult to say if a life time of 25 years is realistic.

Critical points of the design are the strength of the connections between the hooks and the waterproof plates and the UV-resistance of the materials. Also the resistance against overheating may be critical. These properties will have to be further investigated. Furthermore, it must be tested if the space to reach the connection points is sufficient for an easy installation.

10.5. Further steps towards market introduction

The design of the PVT panel as presented in this chapter is ready for the prototyping stages. Different aspects of the design must be tested and further developed. Looking at the technology, the design of the absorber has the first priority. At the same time, a stripped-down panel – without absorber and PV laminate – can be used to test the installation process. The experiences of roofers and thermal installers with these panels and the joining system will have to be collected during user tests. Extended simulations and experiments will have to show if the panels comply with the regulations for solar panels. Besides, simulations and experiments will lead to better insight into the actual performance of the panels.

For a first functional prototype the materials and manufacturing processes have to be set. Within this thesis the materials are only globally chosen, since these choices will be the first to reconsider when a prototype will be build. Furthermore, the materials used in a first prototype will depend on the manufacturer and the available manufacturing processes. The prototype will lead to design improvements and probably a new prototype will be needed to test the effects. Taking an optimistic scenario the panels could be introduced to the market in a demonstration project around 2012.

11. Conclusions and recommendations

Analysis

The Dutch built environment is responsible for about one third of the Dutch energy demand. The potential of solar energy on roofs of houses is by far not enough to take care of this demand. However, with about 127 m² of roofs suitable for solar panels, a large contribution can be made.

PVT panels have a good potential when solar energy becomes a commodity: one type of panel which generates both electricity and heat looks better on your roof and has a higher yield.

There are different types of PVT panels for heating air, water or a combination of both. Within this thesis the focus is on heating water. Heating air becomes interesting if seasonal heat storage becomes available.

The main actors involved in the decision-making process to use solar panels are the taskmaster, installation companies, architects, and occupants. These actors require solar panels to be flexible in dimensions and colours to fit in the environment.

Design

Within the design phase the systems to connect the panels to each other and to the roof were the most important issues. If these systems are designed well, the installation can be much easier and faster.

Three concepts are developed: traditional, plastic, and skylight. Each having its own focus issues, the plastic concept – having a light weight and easy installation – turned out to be the overall best.

Evaluation

The final design consists of panels with a working dimension of 1200 x 900 mm, matching the main dimensions in the building sector. The roof is kept waterproof by special plates, which also provide the system to fasten the panels. Three or four panels of PVT should be sufficient to supply an average household with hot tap water.

The panels have an expected yield of 96 kWh/(m² year) electrically and 265 kWh/(m² year) thermally, given the Dutch environment. With expected panel costs between 400 and 500 euros/panel the panels can keep up with regular PV modules, especially since for the PVT panels attention was also paid to other aspects than performance.

Recommendations

Next steps in the design process involve prototyping and experiments. The absorber has to be designed in detail. Simulations and experiments concerning material strength, UV-resistance, life time and the panel's performance will have to be executed to verify the design and to improve where needed. At the same time user tests with non-functional prototypes will have to demonstrate the functioning of the installation process. Special attention must be paid to the space available to reach the connectors and correct thermal and electrical connection of the panels. With a first test series, the certification process can be started. A demonstration project is the next step, which – in an optimistic view – could be started around 2012. It is recommended that a manufacturer gets involved into the development as early as possible.

Validity

The results of this thesis hold for the Netherlands. The panels can also be used in other European countries, but the performance will differ due to different environmental conditions. Besides, the regulations concerning constructing and safety differ from country to country.

There are no time restrictions considering the validity of the design. However, it is important that the design co-develops with the development of solar cells. Looking at the focus points of the design, it is recommended that thin film or glass-fibre-reinforced composite solar cells are being used when these become commercially available.

References

- [1] Reinders, A.H.M.E., Houten, F.J.A.M. van, 2006, *Industrial Design Method for Product Integrated PEM Fuel Cells*, Proceedings of NHA Annual Hydrogen Conference 2006, Los Angeles, USA, March 2006
- [2] Affolter, P., Eisenmann, W., Fechner, H., Rommel, M., Schaap, A., Sørensen, H., Tripanagnostopoulos, Y., and Zondag, H., 2006, *PVT Roadmap - A European guide for the development and market introduction of PV-Thermal technology*
- [3] Greenpeace International and European Renewable Energy Council, 2007, *Energy [r]evolution - a sustainable world energy outlook*, p. 60
- [4] Zeman, M., 2007, *Solar radiation*, Solar Cells, Delft University of Technology
- [5] Suter, J.M., Letz, T., Weiss, W., and Inäbnit, J., 2000, *IEA SHC - Task 26: Solar Combisystems - Overview 2000*
- [6] Novem, 2003, *Leidraad zonnestroomprojecten*
- [7] Andrén, L., 2003, *The solar heating system in Solar installations - Practical applications for the built environment*, James & James (Science Publisher)
- [8] Informatiecentrum Duurzame Energie, 2003, *Zonneboilers op maat voor projectontwikkelaars*, TH021/19112003
- [9] SenterNovem, 2005, *Zonneboiler(combi) - Warmtewinst door zon*, www.senternovem.nl/ept/maatregelen/verwarming/zonneboilers.asp (accessed 03-03-2008)
- [10] Novem, 2002, *Energiezuinig bouwen met zonneboilers*, 2DEN-02.23
- [11] Zolingen, R. J. C., 2007, *Solar energy (574004) Master SET_UT*, college notes of the course Solar Energy (574004) 2006/2007, Twente University
- [12] Nederlands Normalisatie-instituut, 2007, *Nederlandse voornorm NVN 7250: Zonne-energiesystemen - Integratie in daken en gevels - Bouwkundige aspecten*, ICS 27-160
- [13] Informatiecentrum Duurzame Energie, 2003, *Zonnestroom op maat voor architecten*
- [14] SenterNovem, 2008, *Energie Vademecum*, www.sn-vademecum.nl/VM_inhoud_test.asp?ID_HOOFDSTUK=10&ID_PARAGRAAF=254&VAR_PAR=10.2.1.5 (accessed 01-04-2008)
- [15] Milieu Centraal, 2008, *Zonnepanelen*, www.milieucentraal.nl/pagina?onderwerp=Zonnepanelen (accessed 28-03-2009)
- [16] Zondag, H.A., 2001, *Combined PV-air collector as heat pump air preheater*, Proceedings of 9th Northsun Conference, Leiden, The Netherlands, ECN-RX--02-065
- [17] Elswijk, M.J., 2006, *Photovoltaïsche - Thermische collectoren op passiefhuizen*, Passiefhuis-Platform vzw, pp. 115-121

- [18] Vries, D.W. de, 1998, *Design of a photovoltaic/thermal combi-panel*, PhD dissertation, Eindhoven University of Technology, the Netherlands
- [19] Zondag, H.A., Borg, N. van der, Eisenmann, W., 2005, *PVT D8-6: performance measurement guidelines*, PV Catapult
- [20] International Energy Agency (IEA), 2007, *Task 35: PV/Thermal Solar Systems*, www.pv-t.org (accessed 25-02-2009)
- [21] Zondag, H.A., 2008, *Realized PV/T installations - experiences and monitoring results (draft version)*, IEA Task 35: PV/Thermal Solar Systems
- [22] PVTwins, 2008, *PVTwins*, www.pvtwins.nl (accessed 14-02-2008)
- [23] ZEN Renewables, 2009, *PVTwin, unique solar system*, www.zen-international.com/business/about/news/pvtwin-unique-solar-system/ (accessed 26-02-2009)
- [24] Millennium Electric, 2009, *MSS Multi Solar System*, www.millenniumsolar.com/default.asp?catid={FF7A51A4-4AF9-410D-A2B0-860E9D4F6D2F} (accessed 26-02-2009)
- [25] Solarhybrid, 2009, *Der Hybrid-Kollektor: Gewinnung von Wärme und Strom*, www.solarhybrid.ag/endkunden/ (accessed 26-02-2009)
- [26] Holtkamp Solar Energy Systems GmbH, 2009, *What is a PV-T (hybrid) collector?*, www.solar-energy-systems.eu/DU/index.html (accessed 26-02-2009)
- [27] Solarzentrum Allgäu, 2009, *Kombimodul PV-Therm*, www.solarzentrum-allgaeu.de/PV_Therm/p-2/Typ-PV-Therm (accessed 26-02-2009)
- [28] Milieu Centraal, 2008, *Energie en energie besparen*, www.milieucentraal.nl/pagina?onderwerp=Energie%20en%20energie%20besparen (accessed 28-02-2008)
- [29] Centraal Bureau voor de Statistiek (CBS), 2008, *Woningbouw: Voorraad, wijzigingen en nieuwbouw naar voortgang, per regio*, statline.cbs.nl/StatWeb/publication/?DM=SLNL&PA=7413&D1=0-6,8&D2=0,5-16,754-763&D3=19-20&HDR=T&STB=G1,G2&VW=T (accessed 19-06-2008)
- [30] Ministerie van Volkshuisvesting, Ruimtelijke Ordening en Milieubeheer (VROM), 2006, *Kenmerken woningvoorraad 2006*, vois.datawonen.nl/quickstep/QSReportAdvanced.aspx?report=cijfwov_t10&geolevel=nederland&geoitem=1&period=2006 (accessed 21-05-2008)
- [31] Tolsma, H., 2006, *Waarom wachten op energieneutrale woning?*, Technisch Weekblad – 6 October 2006
- [32] SenterNovem, 2008, *Referentiewoningen nieuwbouw*, www.senternovem.nl/ePN/referentiewoningen/referentiewoningen_nieuwbouw.asp (accessed 21-05-2008)
- [33] Leenders, F., Schaap, A.B., Jansen, W., Ree, B.C.G. van der, Zondag, H.A., Helden, W.G.J. van, Oostendorp, P., 2002, *Technologieverkenning hybride PV/T concepten*, 149.600-708.1

- [34] International Energy Agency (IEA), 2002, *Potential for Building Integrated Photovoltaics – Summary*, IEA PVPS Task 7: Photovoltaic Power Systems in the Built Environment
- [35] BDA Dakadvies B.V., 1999, *BDA Dakboekje 2000*, Ten Hagen & Stam / BDA Dakadvies B.V., Gorichem, the Netherlands
- [36] Monier, 2008, *Collectie geprofileerde dakpanmodellen*, Technisch handboek, pp. 55-116
- [37] Ubbink Econergy Solar GmbH, 2008, *VarioSole*, www.ubbinksolar.com/cmm/userfiles/nieuws/attachments/C401E077-1736-A1E8-B87D-A33522F99B5E.pdf (accessed 17-06-2008)
- [38] Ubbink Econergy Solar GmbH, 2008, *InterSole*, www.renusol.com/fileadmin/content/pdf/intersole/brochure_intersole_nl.pdf (accessed 09-02-2009)
- [39] Itho, 2008, *Montage instructie*, www.itho.nl/Pages/Ithoconsumer.aspx?FrameUrl=../assortiment/ITHO/Verwarming%20en%20warm%20water---2700/Boilers---2767/Zonneboilers---3837/Montageset%20plat%20dak/Zonneboiler.aspx (accessed 19-06-2009)
- [40] Kaan, H.F., Reijenga, T., 2004m *Photovoltaics in an Architectural Context*, Progress in Photovoltaics: Research and Applications pp. 395-408
- [41] DWA Installatie- en energieadvies, Horisun - Renewable Energy Strategies, Piode ontwerp- en adviesbureau BNA, 2002, *Van watermatras tot (architectonisch) bouwelement - Verslag van een workshop over vormgeving en architectonische inpassing van zonneboilers*
- [42] Kets, A., Menkveld, M., Arkel, W.G. van, 2005, *Zon op de daken, zonnige gezichten? - Onderzoek naar meningen over toepassing van PV in Vroonstermeer in Alkmaar en Stad van de Zon in Heerhugowaard*, ECN-C-05-002
- [43] Boer, B.J. de, Kaan, H.F., Jong, M.J.M, Koene, F.G.H., Strootman, K.J., 2003, *De optimale PZE-woning - Literatuurstudie, conceptontwikkeling & voorlopig ontwerp*, ECN-C--03-002
- [44] BRIS BV, 2003, *Bouwbesluit 2003*
- [45] Personal communications with Roel Bakker of Besseling Installaties – Alkmaar, the Netherlands, concerning PVT installation in Overdie, Alkmaar, 23 April 2008
- [46] Nederlands Normalisatie-instituut, 2006, *Nederlandse norm NEN-EN 12976-1: Thermische zonne-energiesystemen en componenten - Fabrieksmatig geproduceerde systemen - Deel 1: Algemene eisen*, ICS 27.160
- [47] Wijco Containers, 2008, *Afmetingen van zeecontainers*, www.wijcontainers.nl/zeecontainer_afmetingen.html (accessed 03-07-2008)
- [48] New Shoes Today B.V., 2007, *37 ways for new product ideas*, version 1.1
- [49] Altshuller, G., Shulyak, L., Rodman, S., Fedoseev, U., 2002, *40 principles: TRIZ keys to innovation*, Technical Innovation Center

- [50] Zondag, H.A., Vries, D.W. de, Helden, W.G.J. van, Zolingen, R.J.C., Steenhoven, A.A. van, 2003, *The yield of different combined PV-thermal collector designs*, Solar Energy 74 pp. 253-269
- [51] Nederlands Normalisatie-instituut, 2001, *Nederlandse norm NEN5128: Energieprestatie van woonfuncties en woongebouwen - bepalingsmethode (appendix D)*, ICS 91.120.10
- [52] Lund, H., 1984, *Test reference years (TRY) weather data sets for computer simulations of solar energy systems and energy consumption (CEC R&D programme solar energy group F solar radiation data)*
- [53] Vries, D.W. de, Zondag, H.A., 2005, *Matlab files to simulate the performance of PVT panels*
- [54] KNMI, 2009, *KNMI Klimaatscenario's: Wind en storm*, www.knmi.nl/klimaatscenarios/knmi06/gegevens/wind/index.html (accessed 25-02-2009)
- [55] Bakker, M., Zondag, H.A., Helden, W.G.J. van, 2002, *Design of a dual flow photovoltaic/thermal combi panel*, ECN-RX--02-047
- [56] VELUX, 2008, *Meer licht is meer ruimte*
- [57] VELUX, 2006, *Inbouw instructies dakvensters - GGU/GGL*
- [58] DEL-BA products, 2009, *ACTIS producten: Triso-Super 9+*, www.delba-isolatie.be/producten_trisosuper9.htm (accessed 09-02-2009)
- [59] Solarnor, 2009, *Solenergi Solarnor AS*, www.solarnor.com (accessed 09-02-2009)
- [60] Suntech Power, 2008, *STP200 - 18/Ub*, www.suntech-power.com/products/docs/STP200_18Ub-1.pdf (accessed 09-02-2009)
- [61] Duffie, J.A., Beckman, W.A., 1991, *Solar engineering of thermal processes*, John Wiley & Sons Inc.: A Wiley-Interscience Publication
- [62] Ubbink Econergy Solar GmbH, 2008, *Installatiehandleiding InterSole SE*
- [63] Ubbink bv, 2009, *Ubiflex, de nieuwe standaard in waterdichte lagen*, www.ubbink.nl/ubiflex/ubiflex/eigenschappen.php (accessed 09-02-2009)
- [64] VELUX, 2009, *Prijslijst - VELUX dakvensters, daglichtsystemen & installatieproducten 2009*

Appendices

Appendix A. Solar energy systems

This appendix describes the functioning of solar thermal collectors and photovoltaic modules in more detail. The working principle, purchase, and future research will be discussed.

A.I. Solar thermal collectors

The built environment in the Netherlands uses 1,000 PJ of energy each year, which is 35% of the overall Dutch energy demand. More than half of this energy is used for heating and cooling of spaces and for heating of tap water [10]. Solar thermal collectors can be used to generate a large part of this energy. In this chapter we will look at the working principle of solar thermal collectors and the different types of collectors that exist.

A.I.I. Working principle

The working principle of a solar thermal collector will be explained on the basis of a drain back solar boiler system, as can be seen in Figure 88. Solar radiation falls on the absorber. The fluid in the collector is heated and pumped around to pass the heat on to the tap water in the boiler. If necessary, the tap water is further heated by a post-heater before it is directed to the place of use. A control unit turns the pump off in case the temperature difference between the collector and boiler fluid becomes too small, or when the water in the boiler has reached a pre-set maximum temperature. Figure 88 shows a thermal solar collector of Dutch Solar Systems (DSS), where the pump is turned on if the temperature difference between the collector sensor and the boiler sensor is 10°C or more. If the temperature difference falls beneath 3°C or the tap water in the boiler reached 80°C or more, the pump is switched off. If the tap water cools down below 75°C, the pump is switched on again. The collector fluid can be drained back to prevent freezing or boiling of the fluid in the collector.

Depending on the size and position of the storage tank, different systems can be distinguished: standard, compact, and central heating solar boiler systems and solar boiler combination systems. The characteristics of the different systems are presented in Table 11. The solar boiler combination system is the only system that is also capable of heating spaces.

The functioning of the systems is based on different working principles [9]:

- The *drain back system* is presented before. Normal water can be used as collector fluid. To guarantee a good drainage, the collector pipes must be parallel connected and the main pipe must be placed under a sufficient large angle. This system is the most common one in the Netherlands.
- In a *fully filled circuit* the collector fluid is also pumped around, but there is not drain back barrel. To prevent freezing of the fluid during the winter, extra substances are added to the collector water.
- A *thermosyphon system* works without a pump. Differences in density due to heating of the collector fluid lead to natural circulation. For proper functioning, the storage barrel must be placed higher than the collector and additives must be used to prevent the collector fluid from freezing. A thermostatic valve is needed to prevent overheating of the system.
- In an *integrated collector storage (ICS) system* the collector and storage barrel are integrated. Circulation within the collector occurs due to density differences. Also this system is prevented from overheating by a thermostatic valve.

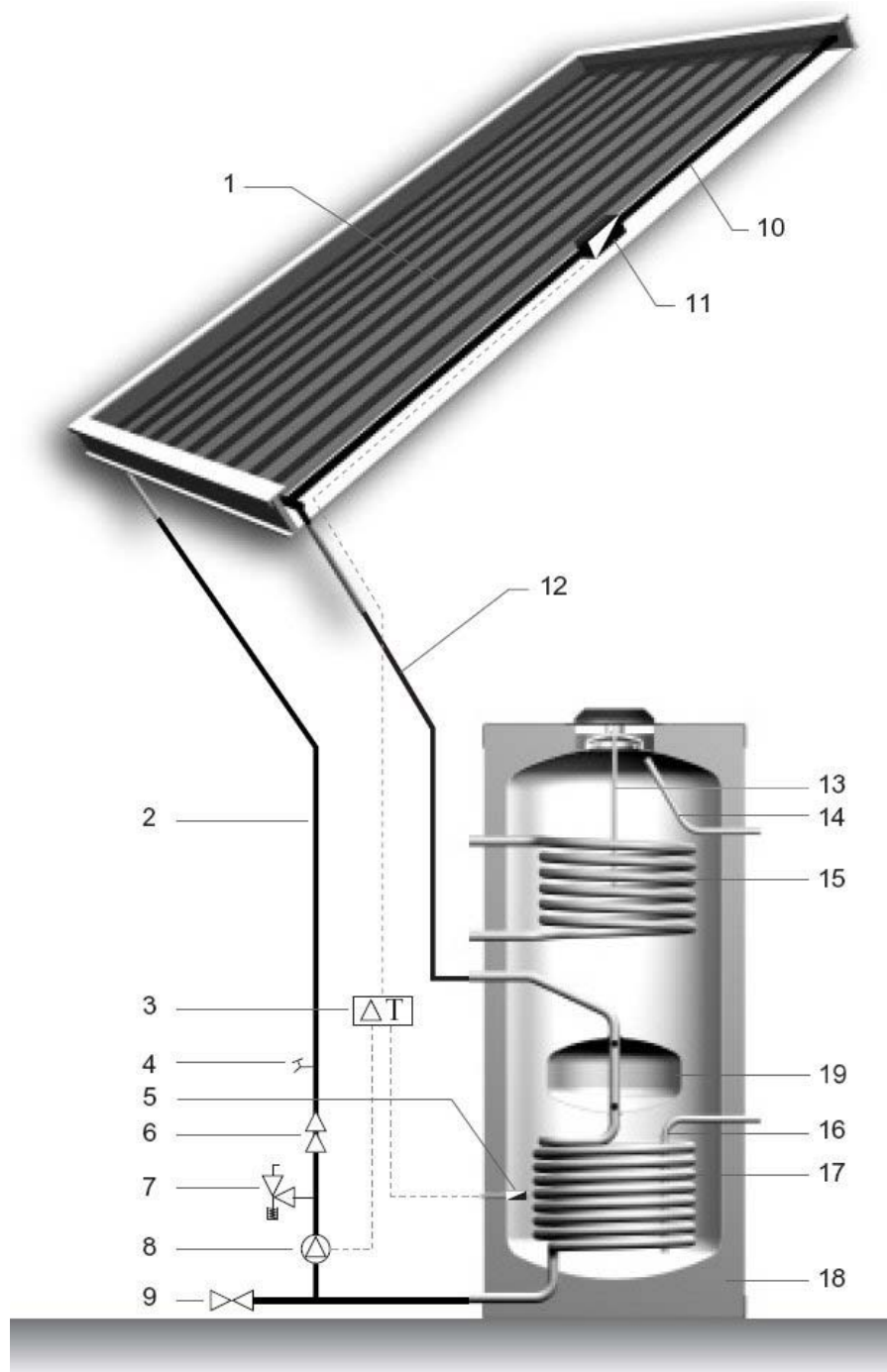

- | | | | |
|----|---|----|---|
| 1 | Collector | 11 | PT sensor (3 wires) |
| 2 | Return pipe collector circuit (cold in) | 12 | Supply pipe collector circuit (hot out) |
| 3 | ΔT control unit | 13 | Plunge pipe for central heating sensor |
| 4 | Draw-off tap | 14 | Tap water (hot out) |
| 5 | PT100 sensor (2 wires) | 15 | Heat exchanger central heating |
| 6 | Circulation limiter | 16 | Tap water (cold in) |
| 7 | Overflow valve | 17 | Heat exchanger solar part |
| 8 | Collector pump | 18 | Insulation material |
| 9 | Filling tap | 19 | Drain back barrel |
| 10 | Absorber | | |

Figure 88: Working principle of a solar thermal collector system [65]

Table 11. Different types of solar thermal collector systems and their characteristics [81

Type	Standard	Compact	Central heating	Combi
Description	Collector plus separate storage tank. Closed system. Post heater necessary. Just for tap water.	Tap water is directly stored in collector. Post heater necessary. No separate storage tank. Just for tap water.	Tapping directly from storage tank. Just for tap water. The central heating boiler keeps the boiler vessel on temperature, if necessary.	Storage tank and central heating burner are integrated. No separate central heating boiler needed. For tap water and space heating.
Collector area	2.8 m ²	2.8 m ²	2.8 m ²	2.8 m ²
Boiler content	100 l	100 – 150 l	140 l	240 l
Boiler dimensions diameter	50 cm	-	50 cm	65 cm
Boiler dimensions height	100 cm	-	140 cm	150 cm
Yield	3.8 GJ/yr	3.8 GJ/yr	3.8 GJ/yr	4.0 GJ/yr
Minimum gas savings	184 m ³	184 m ³	184 m ³	194 m ³
Post heater	Combi boiler or geyser	Combi boiler or geyser	Central heating boiler, heat pump	None
Comfort	+ (if combi boiler)	+	+++ (high)	++
				++
				++

Collector

The collector is the part where the solar irradiance is converted into heat. A solar collector works as a heat exchanger, where the absorber can be seen as the primary side and the collector fluid as the secondary side. There are different working principles to collect as much heat as possible:

- flat-plate collector
- compound parabolic concentrating (CPC) collector
- vacuum (tube) collector.

The basic principle however, is the same for all three options. Therefore the basic principle of a solar collector will first be explained, after which the differences between the types of solar collector will be described.

Solar irradiance is falling onto the collector, which exists of an absorber and possible insulation and/or transparent covers to reduce the heat losses. Part of the incoming irradiance I_0 is reflected (ρ), part is absorbed (α), and the rest is transmitted (τ). An equivalent circuit for a solar thermal collector with two transparent glass plates is presented in Figure 89. From left to right the temperature is given for the ambient, cover 1, cover 2, the absorber plate, the casing, and the ambient again. The upper row of resistances represents the radiative heat losses between the different components, while the lower row represents the conventional heat losses.

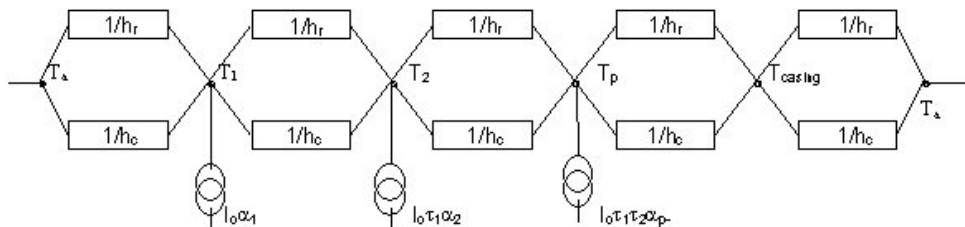

Figure 89: Equivalent circuit of a solar collector with two transparent covers [66]

The absorbed solar energy is represented by the transformers, and equals the light falling onto the considered component, multiplied by its absorption coefficient α . The absorber therefore absorbs an amount of $I_0 \tau_1 \tau_2 \alpha_p$. The energy that is drawn away from the absorber by the collector fluid is \dot{Q}/A .

Flat-plate collector

A flat-plate collector consists of a (usually) black plate to absorb the radiation and pipes to transport the collector fluid, which are hold together by a frame. To reduce heat losses, the frame is well insulated and one or more transparent plates are placed above the absorber, as is schematically represented in Figure 90. Furthermore, a selective spectral coating can be used to reduce heat losses. A spectral selective coating has an absorption coefficient that is in the visible part of the spectrum and low in the infrared part [66].

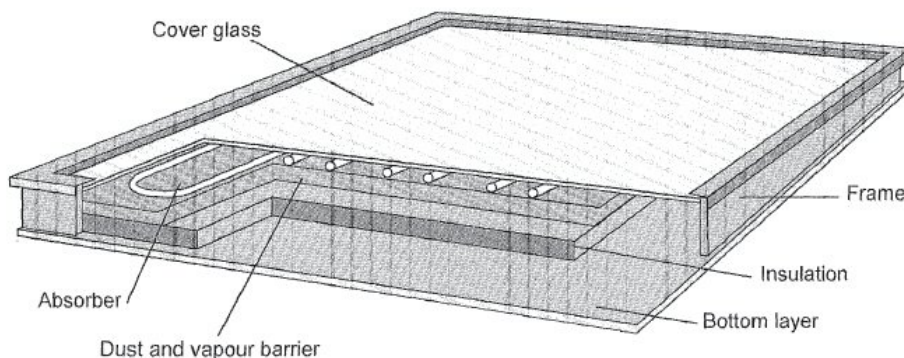

Figure 90: Schematic view of a flat-plate collector [7]

CPC collector

Compound Parabolic Concentrating collectors use mirrors to concentrated the solar radiation and thereby increase the light intensity. Unlike flat-plate collectors, CPC collectors are able to obtain fluid temperatures over 150°C. Since the absorber is relatively small, heat losses are reduced compared to flat-plate collectors. The losses are further reduced by the use of selective spectral coatings and transparent plates on top of the collector, see Figure 91.

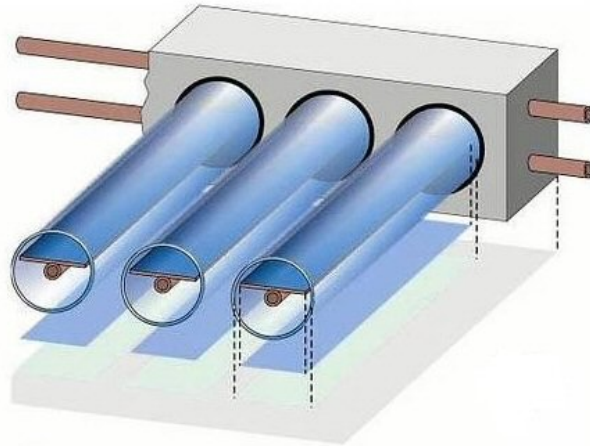
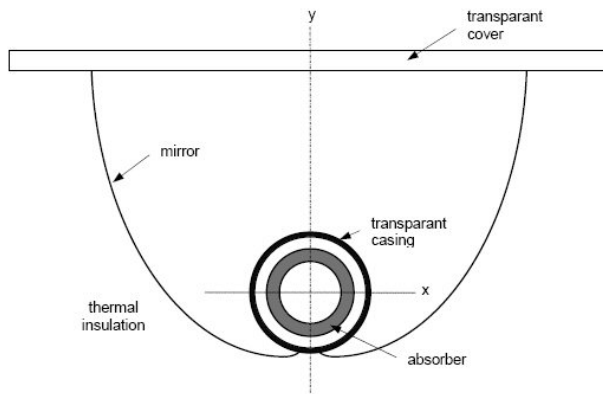

Figure 91: Schematic view of a CPC collector [66]

Figure 92: Schematic view of a vacuum tube collector [67]

Vacuum tube collector

Vacuum tube collectors are used to minimise the convective and conductive heat losses, since these types of heat transport are not possible within vacuum. Tubes must be used instead of flat-plates to withstand the pressure difference caused by the vacuum. Absorbers are placed inside the evacuated tubes, which are connected to pipes to transport the collector fluid, see Figure 92.

Energy losses

Energy losses mainly occur due to radiation and convection and for a small amount by conduction. This is depicted in Figure 93. Reflection, absorption, and transmission occur in every layer of the collector. Spectral selective coatings can be used to reduce the radiative losses.

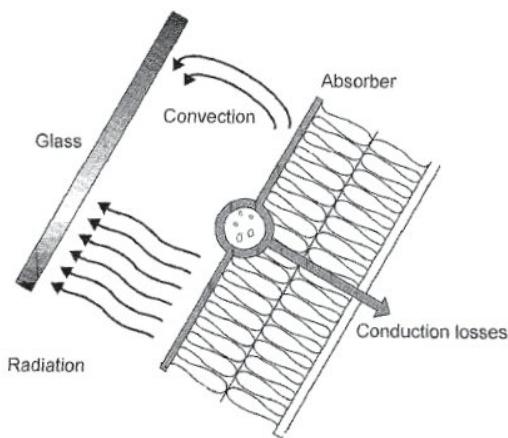

Figure 93: Energy losses in a solar thermal collector

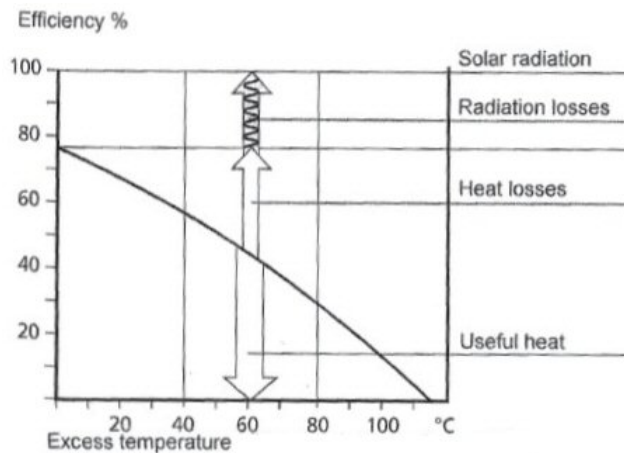

Figure 94: Solar collector efficiency dependency of temperature [7]

Performance

Solar thermal collectors are often dimensioned to supply 50% of the yearly hot water demand of a household. For an average household, this corresponds to 2.7 m² collector surface and a 100 to 200 litres storage barrel [9]. The efficiency of a solar thermal collector is dependent of the temperature difference between the absorber and the outdoor air temperature; the excess temperature. Figure 94 shows the percentage of the solar radiance that is converted to useful heat in the collector. The collector temperature is the average of the supply and return flow.

This equals an average yearly saving of 200 m³ natural gas and a reduction of the Energy Performance Coefficient (EPC) by 0.1 to 0.2 points [8].

A.I.II. Purchase

In newly built houses, solar thermal collectors can be used to achieve the national energy performance coefficient (EPC). Solar thermal collectors are relatively easy to implement and do not ask for changes in the behaviour of the occupants.

With occupants becoming more aware of the environment and climate changes, they start asking for ways to contribute to a better environment, like green electricity. However, these adaptations must have minimum impact on the level of comfort and finances. Solar thermal collectors have no or positive effects on the comfort in a house and reduce the costs for energy. Therefore they are well suited to apply to a sustainable world.

Solar thermal collectors are a mature technology: they comply with the regular regulations concerning electrical safety, fire prevention, and drink water quality [10]. A standard solar thermal collector system costs between €1,400 and €1,800 including installation (excluding taxes) and a solar combi collector system costs about €3,200 [8]. The minimum lifetime of a solar thermal collector system is 20 years [10].

Installation

For a reasonable performance, solar thermal collectors must be placed in a way they receive minimal 85% of the maximum irradiation. Therefore the collectors should be placed between southeast and southwest, under an angle between 30 to 60 degrees [10]. This can be realised by placing the system on or in a sloped roof, or on a flat roof with a special construction, see Figure 95.

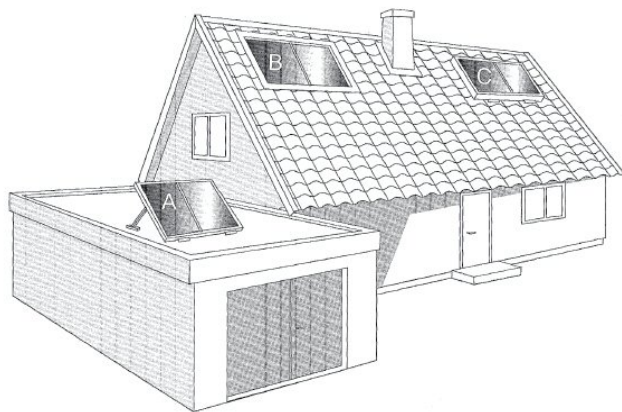

Figure 95: Three ways to position a solar thermal collector on a roof [7]

To install a solar thermal collector system, various connections need to be available close to the collector. The collector system should be connected to:

- the hot and cold water works network for drinking water
- the electricity network for functioning the pump, control system, and post-heater
- the gas network for the use of a central heater
- the sewer for thermosyphon systems and compact solar systems to compensate for overpressure [8].

A.I.III. Future research

Experts have observed five main trends for solar thermal collectors for the coming 20 years: autonomy, integration, modularity, flexibility, and intelligence [68]. This means that buildings will be self-supplying their energy. There will be an integration of buildings and installations, and also components of installations will be integrated. The different components can easily be interchanged with other or newer components and the building is able to adapt to these changes. Moreover, the building and its installations will be able to independently adapt their behaviour to that of the occupants, the weather conditions, and circumstances of use.

Furthermore, research is done to find solutions for the unequal distribution of solar heat during the year. Thermochemical materials (TCMs) may be a solution for seasonal storage of heat.

A.II. PV systems

An average Dutch household uses 3,400 kWh of electricity every year, which is used for domestic appliances, heating, cooling, cleaning, and lightning [28]. Photovoltaic systems can be used to generate part of the electricity needed. In this chapter we will look at the working principle of solar cells, photovoltaic (PV) modules and the different types of PV systems that do exist.

A.II.I. Working principle

Solar cells can convert sunlight into electricity, which is schematically represented in Figure 10. Most solar cells consist of semiconductor materials, like silicon. To improve the conduction of silicon, extra atoms are added to create a p-n junction. The n-type layer contains extra electrons, while the p-type layer contains extra holes to increase the mobility of electrons and holes, thereby increasing the conduction.

If a photon is absorbed by the semiconductor material, an electron can be moved from the ground state to an excited state. This results in an electron-hole pair. An electron-hole pair gets separated by diffusion in the material and an electric field due to the p-n junction. The electrons are collected by the grid contact and reach the back contact via an external load.

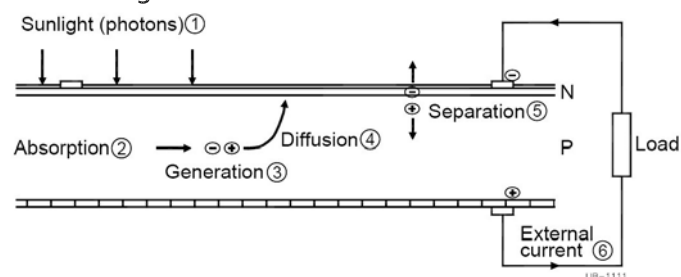

Figure 96: Working principle of a solar cell [11]

The equivalent circuit of a solar cell in its most elementary form can be described by the one diode model, whereas the two diode model, as depicted in Figure 97, represents a more detailed model. In the one diode model, a solar cell is represented by a parallel circuit of a current source and a diode. Imperfections in the production process cause shunt resistances, which are relatively high compared to the series resistances. The series resistances are caused by the resistance of the semiconductor material and the metallization (fingers and bus bars), and by contact resistances between the different materials.

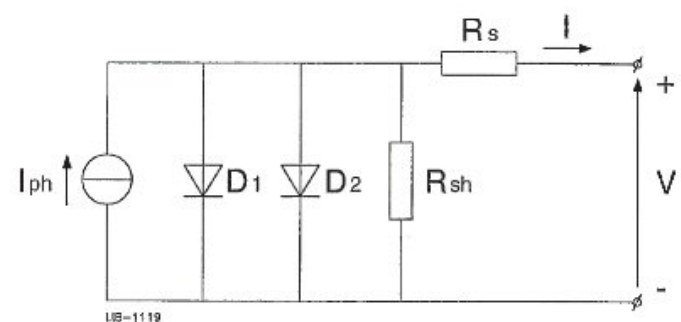

Figure 97: Equivalent circuit of a solar cell, two diode model [11]

The second diode model also represents the recombination in the p-n junction and inhomogeneities that might occur in the solar cell as a whole. The current-voltage characteristic can be described by:

$$I = I_{ph} - I_{s1} \left(e^{\frac{q(v+IR_s)}{n_1 kT}} - 1 \right) - I_{s2} \left(e^{\frac{q(v+IR_s)}{n_2 kT}} - 1 \right) - \frac{V + IR_s}{R_{sh}} \quad (23)$$

Where I_{s1} and I_{s2} are the saturation currents of the diodes and n_1 and n_2 are the quality factors of the diodes [11].

A single solar cell has a voltage of about 0.5 V. By connecting several cells in series, the voltage is increased to 12 or 24 V [15]. An inverter is used to transform the generated direct current (DC) into alternating current (AC) and to further increase the voltage to the usual 230 V. The electricity from the PV module can directly be used inside the building. If there is more electricity supply than demand, the resulting electricity can be supplied to the grid, see Figure 11.

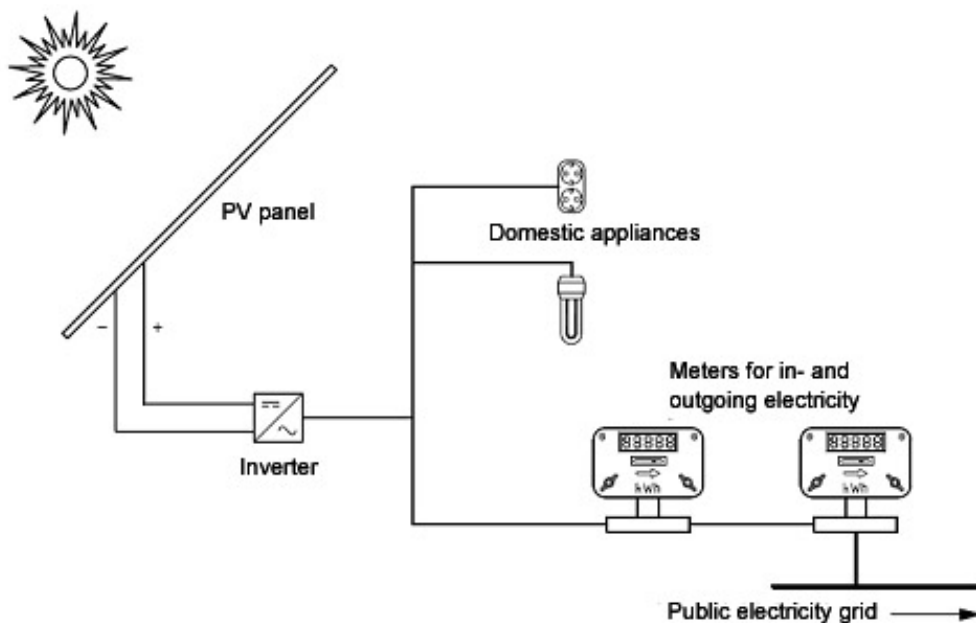

Figure 98: Working principle of a PV module system [12] (source material in Dutch)

Types of solar cells

Different materials are being used for solar cells. Crystalline silicon is the most common one and is used in about 90% of all solar cells. Single crystalline silicon has a slightly higher efficiency than multi crystalline silicon, but is also more difficult to produce.

Besides the crystalline silicon cells exist the thin-film solar cells. Because less material is used in thin-film solar cells, they are generally cheaper and more flexible than the crystalline silicon cells. However, their efficiencies are also lower. The most common used thin-film cells are amorphous silicon cells, but also cadmium-telluride (CdTe) and copper-indium-diselenide (CIS) cells are used.

Gallium-arsenide (GaAs) solar cells are mainly used for space applications and concentrating terrestrial systems because of their high price. Relatively new are the dye-sensitized and plastic solar cells, which (yet) have quiet low efficiencies. In Table 12 typical efficiencies of different solar cells can be found.

Table 12: Efficiencies of different solar cells [11]

Type of solar cell	Efficiency
Single crystalline silicon	16 %
Multi-crystalline silicon	14 %
Amorphous silicon	5-8 %
Cadmium-telluride	8-10 %
Copper-indium-diselenide (CIS)	10-12 %
Dye-sensitised solar cells	5 %
Plastic solar cells	3 %
Gallium-arsenide (GaAs)	30 % (under solar concentration)

Concentrating of solar irradiation is only interesting when a high percentage of the irradiation is direct sunlight. In the Netherlands, there is also a lot of diffuse sunlight, which makes concentrating solar systems less interesting [11].

PV modules

Single solar cells have only a small voltage, which can be increased by connecting multiple cells in series. These series are called strings, and can be connected in parallel to increase the current. Connected solar cells can be encapsulated by a glass substrate, encapsulates (EVA), and a rear-side foil to form a laminate, see Figure 99. A PV module furthermore involves a frame and a junction box. To connect the PV module, also cables, inverters, MPP (maximum power point) trackers, and other electrical components are available.

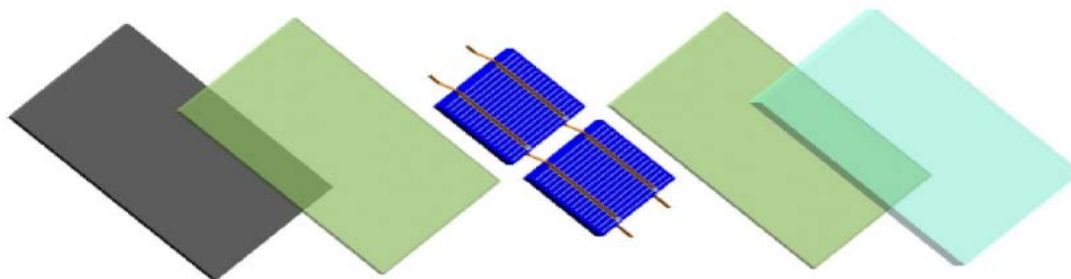

Figure 99: Components of a PV laminate [69]

PV modules are often 700 x 1300 mm or 600 x 1200 mm. The thickness varies between 5 and 10 mm. The typical weight for a PV module is 15 to 25 kg/m² [13].

Performance

A PV system of 500 W – which is about 4 m² – generates approximately 375 kWh per year under the circumstances in the Netherlands. This is more than 10% of the average electricity demand of a household. The Energy Performance Coefficient is reduced by 0.03 to 0.15 points, mainly depending on the type of house [13].

Due to seasonal variations, more electricity will be generated in summer than in winter. Storage of electricity is not required, because electricity that is not directly used inside the building can be supplied to the public grid. If the electricity demand is larger than the supply of the PV system, electricity can be taken from the grid. It is therefore not necessary to size the PV system to the electricity demand of a household.

A.II.II. Purchase

For newly built houses, the use of PV systems can help to achieve the national energy performance coefficient (EPC), although its contribution is less than the use of a solar thermal collector. On the other hand, PV systems have an aesthetical advantage, because they can be integrated better in the roof due to their smaller thickness.

PV systems can meet the increasing demand of occupants to contribute to a better environment, without losing comfort. The CO₂ emission of PV systems is 50 to 60 grams per kWh, due to emissions during the production phase. If we compare this to the CO₂ emissions of coal (850 grams per kWh) and natural gas (400 grams per kWh), it turns out that after 3 years PV systems have saved as much energy as the amount of energy that has been used to produce them [15].

PV systems cost approximately €4.50 to €6.00 per W_p: this is about €500 to €750 per m². The prices include the entire system – consisting of the PV module, inverter, cables, and installation frames – but exclude the installation costs and taxes [14].

PV systems pay themselves back energetically within 3 years. Although PV systems last for a minimum of 25 years, it is financially not yet possible to get back the investment by simply saving energy. Solar energy costs about €0.55 per kWh, while conventional electricity costs €0.22 per kWh [15]. Nevertheless, with the help of (national) subsidies PV systems may become attractive to invest in sustainable energy.

Installation

Like solar thermal collectors, PV systems can be placed on or in sloped roofs, or on a flat roof with a special construction, see Figure 95. PV systems have an optimal performance when placed facing south under an angle of 36 degrees compared to the horizontal plane. Small deviations from the optimal situation have only small effects on the performance, as can be seen in Table 13. Therefore in practice PV panels may be oriented between south-east and south-west under an angle of 20 to 50 degrees [13].

Table 13: Performance at different orientations compared to optimal situation [13]

Angle of slope	South	South-west / south-east	West / east	North
Flat roof	87%	87%	87%	87%
30°	98%	95%	84%	65%
45°	97%	94%	78%	52%
60°	94%	88%	73%	42%
Façade	74%	70%	56%	33%

It is important that the shadowing of the solar cells is minimised, since a PV module only functions as well as the poorest cell. Shadowing can therefore largely decrease the performance of the system. Shadowing often appears through chimneys, trees, and other buildings when the sun is fading.

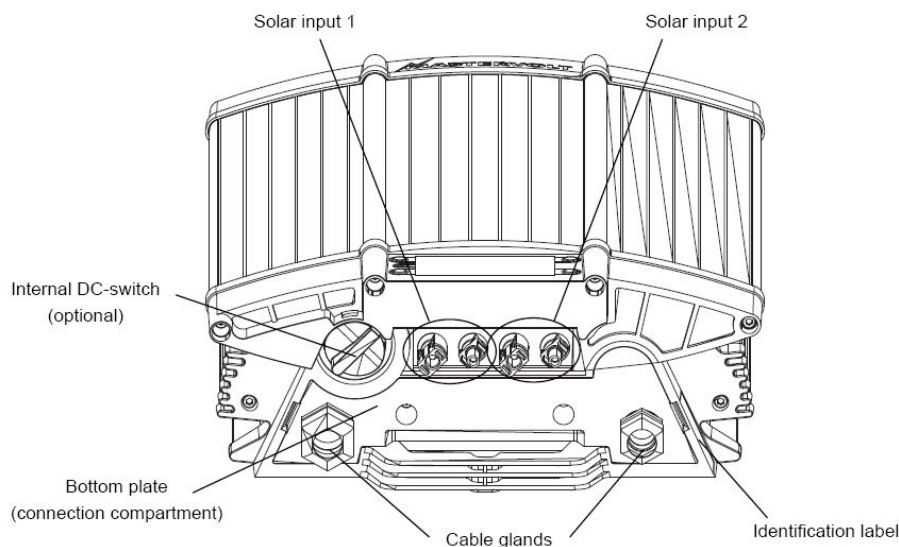

Figure 100: Connections of an inverter [70]

To install a PV system, the PV modules are connected to the grid via an inverter. From the PV panel come two cables, plus and minus. These cables can only be connected in one way to the inverter by an easy clicking connection. The AC cable from the inverter can be put into a regular earth socket, possibly via an earth leakage circuit breaker. Figure 100 shows the connections of a Philips PSI 300 inverter.

PV systems up to 600 W may be connected to a single group in the fuse box. For larger power, a special group is needed [15].

A.II.III. Future research

Lots of research is being done on improving efficiencies and production processes of PV cells and modules. The price of PV cells is expected to decrease further.

The development of flexible cells of amorphous silicon is becoming interesting for applications where curved surfaces are desired. With an efficiency of 6% these cells are, however, still far less efficient than crystalline cells [71]. The development of transparent and plastic solar cells may also offer good opportunities for future implementation.

References:

- [65] Dutch Solar Systems, 2008, *Installatiehandleiding DSS*
- [66] Helden, W.G.J. van, 2004, *Solar Collectors*
- [67] Deutsche Gesellschaft für Sonnenenergie e.V., 2008, *Sonnewärme (Solarthermie)*, www.dgs.de/137.0.html (accessed 05-05-2008)
- [68] Helden, W., Bakker, M., Amerongen, G. van, Visser, H., 2007, *Zonnewarmte heeft de toekomst in Nederland*, VV+ – May 2007
- [69] ECN - Solar energy, 2008, *PV Module Technology*, www.ecn.nl/en/zon/r-d-programme/pv-module-technology/ (accessed 28-03-2008)
- [70] Mastervolt, 2008, *User's and installation manual - Sunmaster QS2000 IP44*, www.mastervolt.com/view_product.php?section=Solar%20Grid%20connecte&prggr_id=1160&group=Solar%20Inverters%201-10%20kWp&prg_id=1149&pro_id=6002&prg_name=Sunmaster%20QS%20series (accessed 21-07-2008)
- [71] Weijers, E.P., Groot, G.J. de, 2007, *Energiewinning uit weginfrastructuur - Inventarisatie in opdracht van "Wegen naar de Toekomst*, Innovatieprogramma Rijkswaterstaat, ECN-E--07-057

Appendix B. Visit to PVT installation in Overdie – Alkmaar

To get insight into the installation of PVT panels and the experiences of installers, a PVT project is visited. The outcomes of the visit will be used for the formulation of the program of requirements.

Background of the project

Within the frameworks of the restructuring of the district Overdie in Alkmaar (the Netherlands), 154 single-family dwellings will be radically renovated. The dwellings are owned by the housing association Woonwaard Noord-Kennemerland. This project is the first large-scale application of PVT in the house building sector. The PVT panels have an area of 2.5 m² [72].

On 23 April 2008, six PVT panels were installed on six row houses in Alkmaar. On the scaffold were present executive installer Roel Bakker of Besseling Installations B.V., another senior installer, two apprentice installers and two roofers.

Initially, the roofers would install the PVT panels on the roof. However, since they did not know how to do this, the installers were asked to do this, since they have experience with installing solar energy systems. The initial work of the installers in this project involved only the installation work inside the houses.

The following information is obtained by observing the installation process and questioning the installers.



Figure 101: PVT panel

PVT panel

The PVT panels are made by PVTwins. The panels are originally part of drain back systems, but due to the position of the panels on the roof, this was not possible. The panels are adapted and now form a fully filled circuit filled with water and antifreeze. The PVT panels are lifted on the scaffold by a crane and are packed in cardboard. Two sides are equipped with lifting handles (not to be used by the crane).

From the panel come two pipes (hot and cold fluid) and three cables (plus, minus, and PV temperature sensor). Due to the adaptation, all pipe and cable ends are located at the same place.

B.I. Installation

The day before the installation of the PVT panels, the roof has been prepared. This involved the measuring of the exact position of the panels, in consultation with the roofers, to connect as much as possible to the roof tiles. Furthermore, the tile laths must be sawed, as does the hole in the roof for the pipes and cables.



Figure 102: Roof preparation



Figure 103: Positioning of PVT panel

Next is the placing of the PVT panel on the roof. Due to the weight of the panel – about 70 kg – this is a task that needs to be done by four persons. The panel must be placed in a way that the pipes and cables go through the hole in the roof. To prevent damaging the pipes and cables, the panel can not be shoved over the tile laths, but must be lifted. The holes for the screws in the sides of the panels must be above the tile laths. The bottom of the PVT panel must be on the same height as the bottom of the lowest roof tiles. The positioning of the panel takes a lot of time compared to the other steps.

When the panel is fastened on the tile laths by screws, the gutters can be placed. There are three gutters needed: one for the top and two for the sides. Since the roof ends at the bottom of the panel, no gutter for the bottom is needed. The gutters are clicked under the border of the PVT panel to prevent rain to flow under the panel. The top gutter is placed over the side gutters.



Figure 104: Top and side gutter

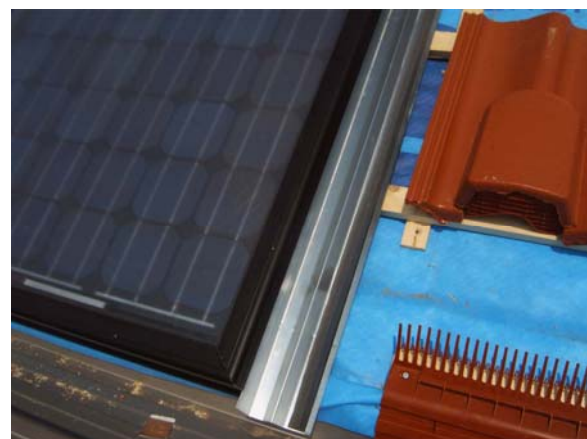

Figure 105: Side gutter

The work of the installers on the roof is now finished. The roofers can complete the roof by placing the roof tiles. Due to the earlier consultation, the roof tiles on the sides of the PVT panel do not need to be adapted. The roof tiles above the PVT panel need to be cut to the right size.



Figure 106: Top of the installed PVT panel



Figure 107: Bottom of the installed PVT panel

The PVT panel must now be connected to the electricity grid and central heating system. This takes place in the attic of the house. The cables coming from the panel must be plugged into the inverter, which is connected to the socket. The pump, expansion vessel, and boiler must be placed and connected. The pipes coming from the PVT panel get connected to the pump. The exact placement of the pipes differs per situation, depending on the position of all components and what the installer thinks is best.

The installation of the complete central heating system (based on the existing system) takes about 1 day for 1 installer.

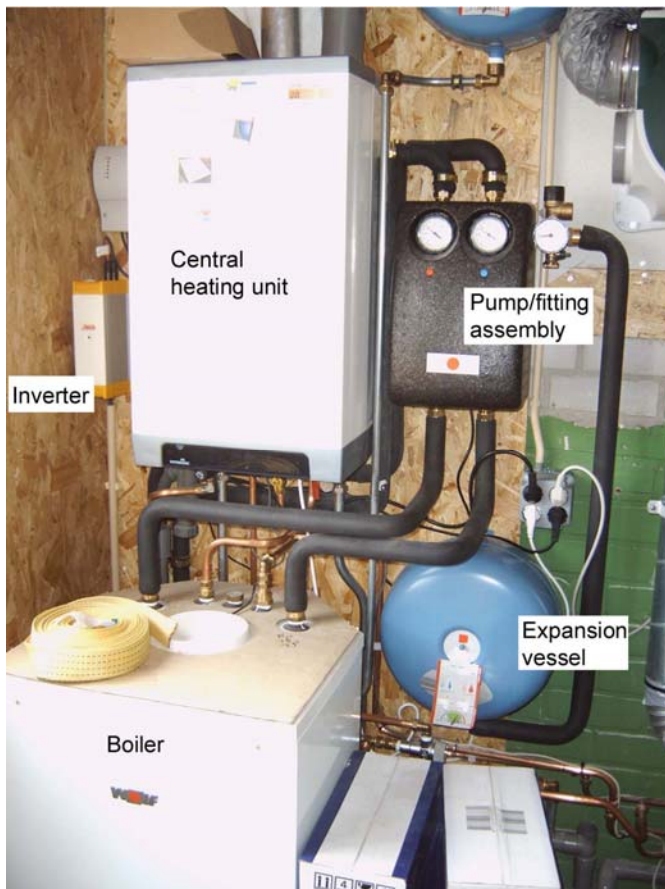

Figure 108: Installation inside the house

The PVT panels are now installed. The positioning, fastening, and placing of the gutters took about 1.5 hours for six panels. Included clips for the connections of the PVT panels on the tile laths remain unused.



Figure 109: Final result of the PVT installation

B.II. Remarks

The installers point out that the PVT panels are quite heavy. It may be easier to place the PVT panels with the help of a crane. The bottom of the PVT panels might be positioned equal to the lower roof tiles, after which the panel can be turned over to its final position. With the current (adapted) panels this is not possible, since the PVT panels can not be shoved. The positioning of the PVT panels would however be easier if the bottom of the panel could be placed on a tile lath.

The question is asked if it is useful to use two systems (solar thermal collector and PV panel) into a single product. If one system fails, so will the other. However, the installers seem generally positive about the PVT system, suggesting they might be used in all newly built houses. Feedback to the habitants about the functioning and generated energy would be useful, to get the habitants involved and reduce the risk of non-functioning systems over a long period, since habitants know when to call a specialist for check-up.

They think the installation of a PVT system is very much comparable to the installation of solar thermal collector systems. Solar systems are no regular part of the education. In earlier days, a solar system course was necessary, but because the modules have become easier, this is not necessary anymore. The PVT collectors are delivered with a manual with pictures. Without this manual you need to stay focussed for the installation, but it is reasonable intuitive.

Reference:

- [72] SenterNovem, 2005, *Innovatief renoveren met PVT-zonne-energiesystemen*, www.senternovem.nl/eos/projecten/eos_demonstratie/2005/innovatief_renov_eren_met_pvt-zonne-energiesytemen.asp (accessed 23-05-2008)

Appendix C. Visit to installation company Solar-id – Bodegraven

To get more insight in the installation of solar thermal collectors and PV modules, a solar systems installation company is visited. The outcomes of the visit will be used for the formulation of the program of requirements.

Background

Solar-id is the sustainable energy part of the installation company Walraven&Zn in Bodegraven. Solar-id does the selling, installation, and maintenance of both solar thermal collectors and PV modules to private persons. On 17 July 2008 I visited the company, where I had a conversation with Mr. Bart Walraven, who has years of experience with installing solar panels. The conversation mainly focused on solar thermal collectors. These collectors have an area of 2.5 m² and a weight of 43 kg. The following information represents the opinion of Mr. Walraven.

Installation

Walraven&Zn is from origin a heat-installing company. The experience has learned that electric installers are shivery to work on the roof. Heat installers already have to be on the roof when they install thermal collectors. It is then a small effort to also install a PV module or PVT panel.

Installation of solar thermal collectors generally takes about 12 to 13 man-hours, but also 16 man-hours are not unusual. The installation includes the building of a scaffold or other safety measurements for working on the roof, removal of roofing tiles, placement and connection of the collector, replacement of the roof tiles, and in-house connection of the collector to the heating system. In the morning, two men place the collector on the roof. In the afternoon, one man connects the solar collector inside the house. It is preferred that a specialised roofer removes and replaces the roof tiles.

The collectors are fastened to the tile laths by screws and neoprene rings for the water tightness. The changeover between the collector and the roof tiles is made watertight by gutters and a counter flashing. The counter flashing is placed before the collector on the bottom side. The counter flashing can support the collector, so the installer has his hands free for exact positioning and connecting. After that, the gutters can be pushed under the borders of the collector. The gutter system is comparable to the one used for the PVT installation in Alkmaar – see Appendix B – and partly developed by Mr. Walraven himself. The roof is now watertight. If wanted, the connection of the collector to the heating system could be done at a later moment.

To prevent all different sizes of roof tiles from connecting badly to the collector, the gutters are available in two widths. This gives three different sizes for the collector plus its gutters, which in practise assures that the collector can be installed water tightly on any roof, independent of the dimensions of the roof tiles.

The gutter system is only usable for portrait installed panels. Landscape panels need another system. Large synthetic panels are placed on the roof and get partly covered by roof tiles. The roof is now watertight. On the synthetic panels, aluminium braces are placed for the connection of the collector. This system is comparable to Ubbink's InterSole system (see also page 26).

Drain back system vs. fully filled circuit

In the Netherlands drain back systems are the standard for thermal collectors. They have the advantage that water has better heat transfer properties than the glycol used in fully filled circuits. These latter systems however, have the advantage that there is much more freedom for the installer to decide where the system goes through the roof and where the boiler is positioned. Mr. Walraven prefers the fully filled circuits because of this positioning freedom.

Costs

Installation costs are a significant part of the acquisition costs. The purchase of a thermal collector is about € 1,100 and the installation costs are about € 800. To convince people to use solar systems a pay back time of 8 to 10 years is acceptable. For most people the pay back time is the most important aspects; aesthetics are less important. The pay back time is therefore very important.

PVT systems

Mr. Walraven is familiar with the PVT principles. He questions if it will be better than side by side thermal and PV systems. PV cells must be as cool as possible, while the absorber of a thermal collector must be as hot as possible and therefore the requirements for PVT panels are contradictorily. Besides, PV modules and thermal collectors can be made with the same frames and dimensions, which makes them look alike.

Architects will probably like PVT panels, since they realise a single style for solar energy panels on the roof.

PVT will mainly be suitable for (large) new housing development projects and retrofit projects. Within these projects it is possible to work with the help of a crane, which makes the installation process easier and faster. Furthermore, if several houses of the same type are supplied with PVT panels, it takes relatively less time to measure the exact position of the panels.

Possibilities for improvement

The installation of current thermal collectors is fine, there are little problems and there is less to improve. Getting the collectors on the roof more easily may be one of the little points for improvement.

The weight of thermal collectors is quite high, but it will be very hard to reduce this. The main contributors to the weight are the glass plates. All other components – very thin absorber, aluminium frame, insulation – are already about the minimum weight they can be.

At the moment, the production of the upper gutter involves a lot of (manual) cutting, which makes the process non-optimal. This could probably be improved. Mr. Walraven is also working on new ideas to improve the shape of the gutter or the production process.

Appendix D. Questionnaire interviews with architects

The following text is the (Dutch) questionnaire for the telephonic interviews with architects. This questionnaire is used as a guideline; the line of the conversations may deviate from the questionnaire. The set-up of the questionnaire is based on the book of Dijkstra and Smit.

Introductie

Goedemorgen/-middag, met Mieke Timmerman van het Energieonderzoek Centrum Nederland. Wij doen momenteel samen met de Universiteit Twente onderzoek naar de integratie van zonnepanelen in woningen. Zou ik u daarover een aantal vragen mogen stellen? Het duurt ongeveer 10 minuten.

Maar ik heb geen ervaring met zonnepanelen.

Juist architecten die nog niet met zonnepanelen hebben gewerkt zijn erg interessant voor dit onderzoek, omdat we graag willen weten hoe architecten die nog niet met zonnepanelen hebben gewerkt over deze techniek denken.

Waarvoor wordt het onderzoek precies gebruikt?

Aan de hand van deze interviews wordt bepaald welke eisen architecten aan zonnepanelen stellen. Hierdoor wordt het mogelijk om een nieuw type zonnepaneel te ontwerpen dat goed toegepast kan worden door architecten bij het ontwerpen van duurzame woningen of nieuwbouwwijken.

Hoe weet ik dat het een echt onderzoek is? Iedereen kan wel bellen.

Dat ben ik helemaal met u eens. Als u wilt kan ik u het telefoonnummer geven van ons onderzoeksinstituut. Dan kunt u bellen om te vragen of het klopt. U kunt het nummer ook zelf op internet opzoeken en dan vragen naar Marco Bakker. (U kunt het telefoonnummer vinden op www.ecn.nl, onderaan de pagina: 0224-56.4949)

Zijn de gegevens vertrouwelijk?

Alle gegevens worden vertrouwelijk behandeld. Antwoorden en opmerkingen kunnen nooit tot u persoonlijk worden herleid.

Vragen

1. Heeft u al eens aan projecten gewerkt waarin zonnepanelen of zonneboilers werden gebruikt?

Ja → Vragenlijst Architecten met zonne-energie ervaring

Nee → Vragenlijst Architecten zonder zonne-energie ervaring

Architecten met zonne-energie ervaring

2. Kunt u kort aangeven wat voor projecten dit waren, zodat wij een beeld krijgen van uw ervaring met zonnepanelen en zonneboilers?

Evt. toelichting:

Bijvoorbeeld hoeveel huizen en wat voor technologieën?

3. Kunt u aangeven waarom er bij deze projecten voor is gekozen om zonnepanelen of zonneboilers te gebruiken?

Niet opnoemen:

Goed voor het milieu

Energie besparen

Groen imago van ...

Eis of wens van opdrachtgever

...

Evt. vragen als het niet al genoemd wordt:

Wie heeft bepaald dat er zonne-energie in de woningen gebruikt zou worden?

4. a. Bent u tevreden met de mogelijkheden om de huidige zonnepanelen en zonneboilers in woningen te integreren?

Indien toelichting gewenst is:

Bij de huidige zonnepanelen kunt u denken aan de blauwe panelen van ongeveer 1 meter bij 1 meter 60, zoals die op verschillende daken te zien zijn.

- b. Kunt u aangeven waarom wel/niet?

5. a. Wat vindt u dat een zonnepaneel of zonneboiler zou moeten uitstralen?

- b. Vindt u dat de huidige zonnepanelen dit voldoende uistralen?

6. Als u de zonnepanelen mocht veranderen zodat ze goed in uw ontwerpen te gebruiken zijn, hoe zouden de zonnepanelen er dan uitzien?

Evt. doorvragen:

Met welke afmetingen kunt u het beste uit de voeten?

Zou u naast blauwe panelen ook graag gebruik maken van andere kleuren?

Zijn rechthoekige panelen goed bruikbaar, of zouden andere vormen handiger zijn?

Architecten zonder zonne-energie ervaring

2. Is het een bewuste keuze om geen gebruik te maken van zonnepanelen of zonneboilers, of is zonne-energie eigenlijk nog niet ter sprake gekomen als ontwerpmogelijkheid?

Indien bewuste keuze:

Kunt u aangeven waarom u geen gebruik wilt maken van zonnepanelen of zonneboilers?

3. a. Wat vindt u dat een zonnepaneel of zonneboiler zou moeten uitstralen?
b. Vindt u dat de huidige zonnepanelen dit voldoende uistralen?

4. Als u de zonnepanelen mocht veranderen zodat ze goed in uw ontwerpen te gebruiken zijn, hoe zouden de zonnepanelen er dan uitzien?

Evt. doorvragen:

Met welke afmetingen kunt u het beste uit de voeten?

Zou u naast blauwe panelen ook graag gebruik maken van andere kleuren?

Zijn rechthoekige panelen goed bruikbaar, of zouden andere vormen handiger zijn?

Afsluiting

Dank u wel, dat was de laatste vraag over dit onderwerp. Ik heb nog een paar afsluitende vragen voor u.

Met dit onderzoek inventariseren we de wensen en eisen van architecten voor het integreren van zonnepanelen in woningen.

1. Stelt u prijs op een samenvatting van de resultaten van dit onderzoek?

Indien ja:

Waar mag deze samenvatting heen gestuurd worden?

Naam:

Adres:

E-mail:

Als vervolg op dit onderzoek zal een ontwerp gemaakt worden voor een nieuw type zonnepaneel. Hiervoor zal in juni een workshop gehouden worden met verschillende partijen die betrokken zijn bij de integratie van zonnepanelen in de woning.

2. Heeft u interesse om ter zijne tijd een vrijblijvende uitnodiging voor deze workshop te ontvangen?

Indien nee:

Echt niet? De uitnodiging zal meer informatie bevatten over de precieze inhoud van de workshop. U kunt daarna altijd nog bepalen of het u de moeite waard lijkt om mee te doen.

Indien ja:

Mag ik de uitnodiging naar hetzelfde (mail)adres sturen als de samenvatting van de resultaten?

OF: Waar mag ik de uitnodiging naar toe sturen?

Naam:

Adres:

E-mail:

Dank u wel, u kunt eind mei, begin juni een uitnodiging verwachten met meer informatie over de inhoud van de workshop.

Dat waren alle vragen. Heeft u zelf misschien nog vragen?

Dan wil ik u graag hartelijk bedanken voor uw medewerking. Tot ziens.



Reference:

Dijkstra, W., Smit, H.J., 1999, *Onderzoek met vragenlijsten : een praktische handleiding*, Amsterdam: VU Uitgeverij

Appendix E. Idea generation

How does the shape of the panel fit to the different shapes of the roofs?

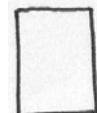
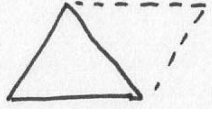

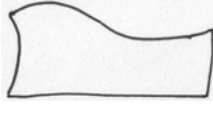
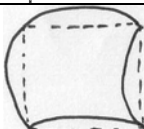
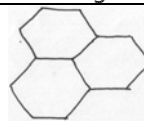
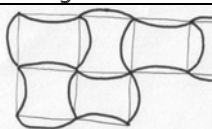
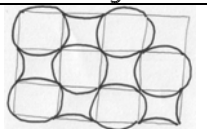
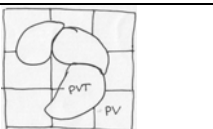
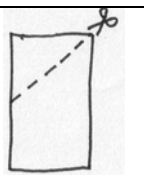
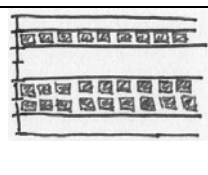
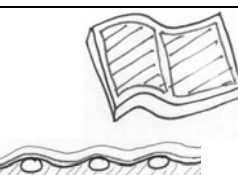
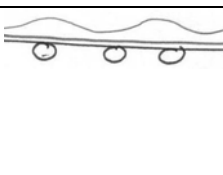
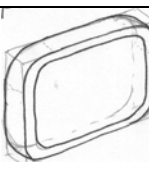
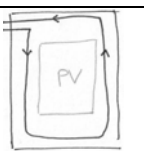
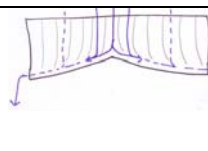
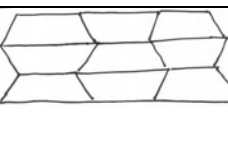
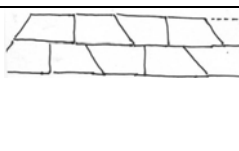
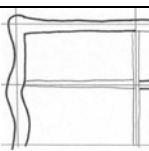
- Points of attention:
- The panels should fit together.
- Different configurations of the panels can be made.

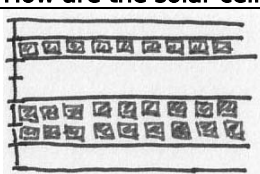
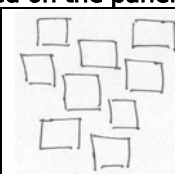
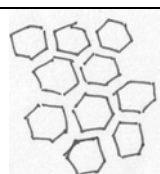
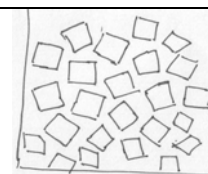
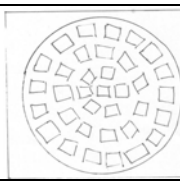
Possible shapes of the panels				
				
Squares	Rectangle	Triangle	Parallelogram	
				
				
Cut to right size	Venetian blinds	Roof tiles	Glass covering as roof tile	Rounded corners
				
Middle is PV, edges is thermal	Water draining top of panel	Trapezium		Top covering to change the visible shape

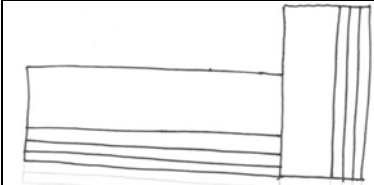
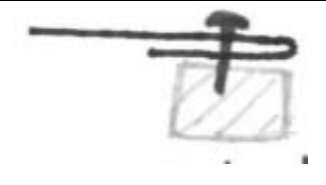
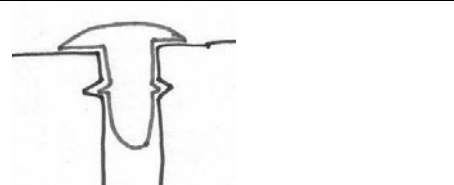
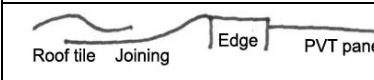

How are the solar cells placed on the panel?			
			
Complete fill	Cells apart from each other	Different cell shapes	Rotated cells
			
Square panel with cells in a circle			

How is the joining between the panels and between the panels and the roof?

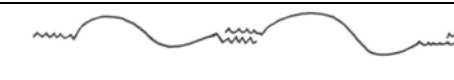
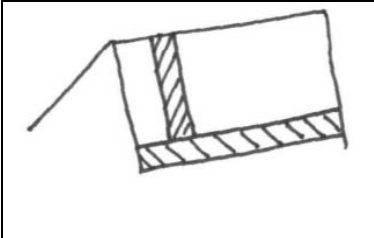
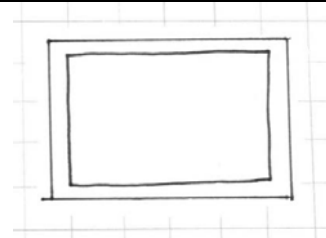
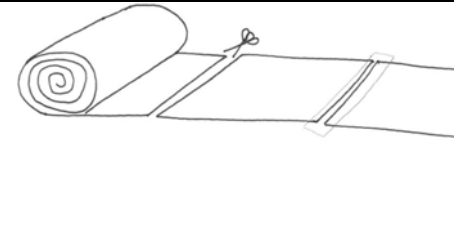
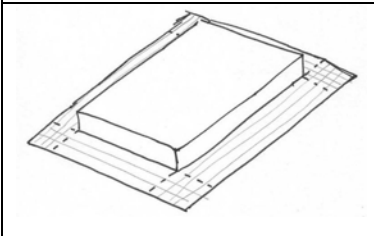
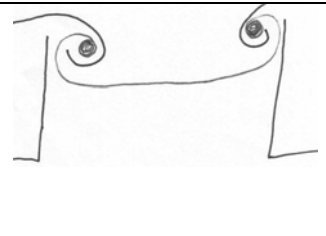
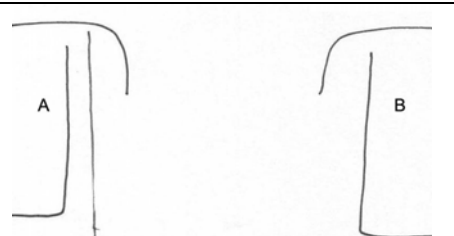
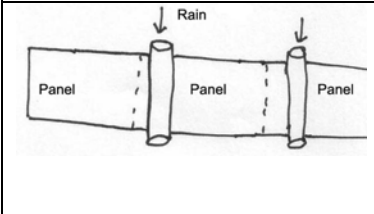
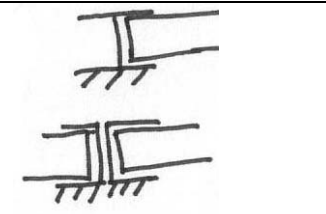
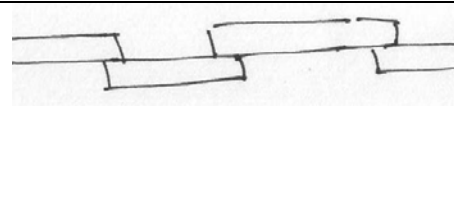
- Points of attention:
- the roof must remain watertight
- rain must be drained
- roofs have a large tolerance (order of dimensions is cm)

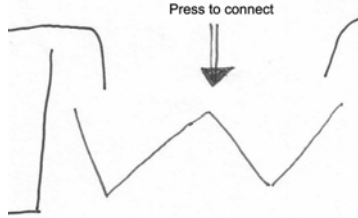

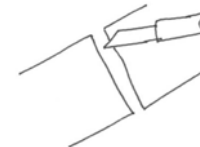
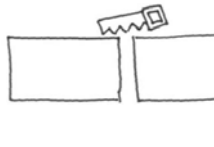
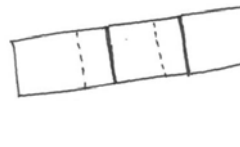
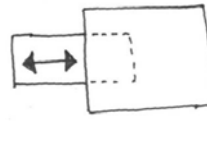
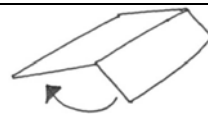
		
Plastic gutter pieces that can be cut* to fit exactly between the panels and the roof.	Flexible gutter pieces nailed onto the pan laths.	Top strip to cover the narrow opening between the panels and/or the roof. The strip can be cut* to the right length and width.
		
Flexible strip attached on the panel is put under another panel or under the roof tiles.	Flexible strip later on attached to the panel.	Panels made as roof tiles. Flexibility by the distances the panels overlap.
		
Panels over the entire length or width of the roof reduce the number of joinings needed.	Place the panel(s) in a skylight or use the construction of a skylight.	One or more plastic layers under the panels to keep the roof watertight. Layers can be combined by overlapping or pasting.
		
Panels have overlapping (gutter) wings.	Flexible foil is hung up under the panels edges.	Gutter of panel A fits under the edge of panel B.
		
Connect the panels to tubes that also drain the rain water.	Panels are placed into I-profiles.	Two different layers of panels overlap.

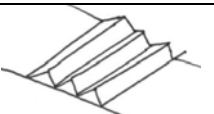
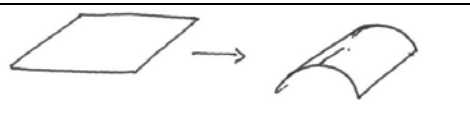
		
Flexible gutters that hold on to the panels.		

* How can parts be cut to fit flexible in dimensions?				
				
Cutting (1)	Cutting (2)	Sawing	Overlapping	Shoving
				
Folding	Breaking	Ribbing	Bending	

How can the panels be attached to the roof?

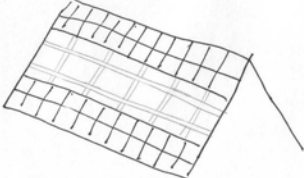
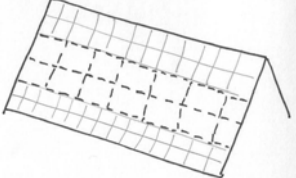
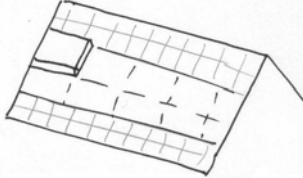
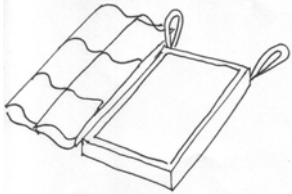
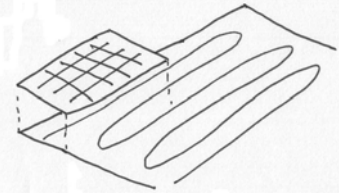
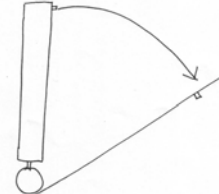
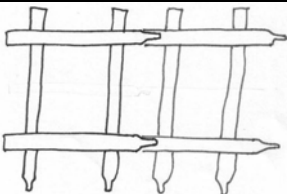
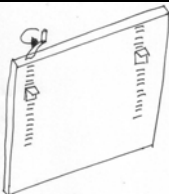
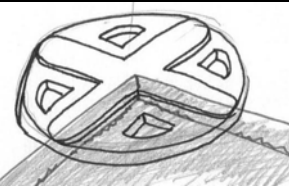

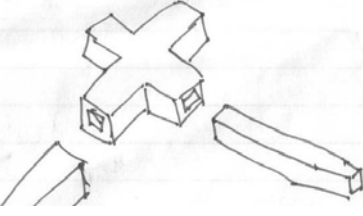
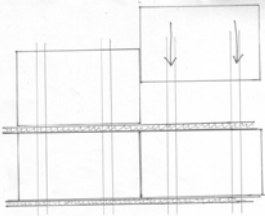
- Points of attention:
- Panels can be placed in different positions and combinations.
- Because of the weight, it is difficult to position the panel and then get a hand free to fasten the panel.

		
<p>Remove the roof tiles and connect the panels to the pan laths.</p>	<p>The panels are easily positioned on a special, watertight underground.</p>	<p>A panel is supported by the pan laths. The installer now has two hands free to properly attach the panel to the roof.</p>
		
<p>Use the lifting nooses to globally position the panel.</p>	<p>The thermal part of the panel is integrated in the watertight underground. Regular PV laminates are used as top layer.</p>	<p>The bottom of the panel is supported by a sort of hinge, which makes it easier to position the panel to its final position.</p>
		
<p>Use a frame that can be easily extended by shoving or adding pieces.</p>	<p>Hooks on the back of the panel help with global positioning.</p>	<p>The panels are placed onto a raster with connection points at standard distances.</p>
		
<p>Simple elements form a frame. The tubes used can be closed to fasten the panels.</p>		<p>Leading rails on the pan laths help position the panels. The horizontal rails carry the weight of the panels above.</p>



How can the panels be thermally connected?

Points of attention:

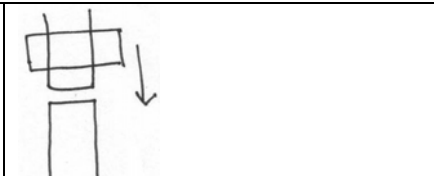
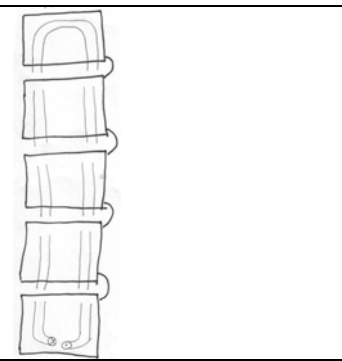
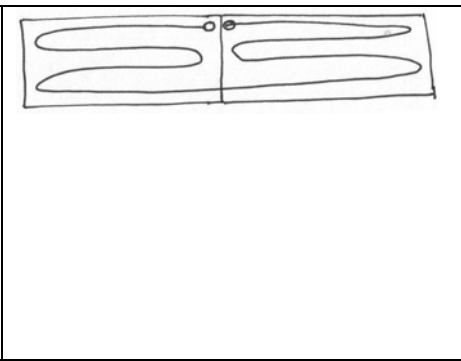
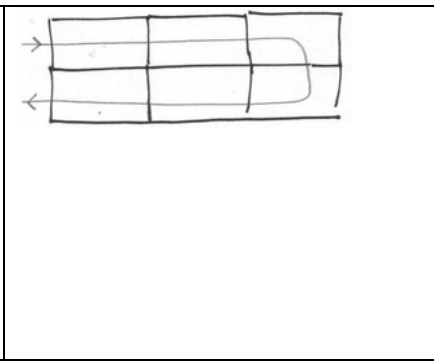
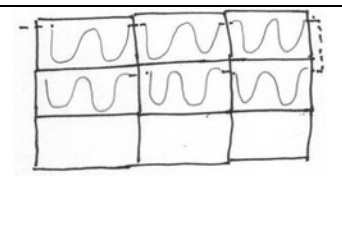
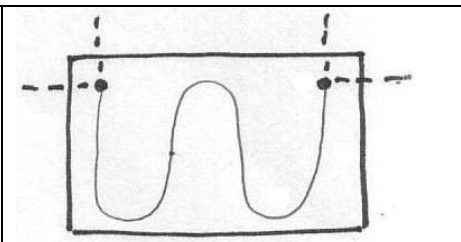
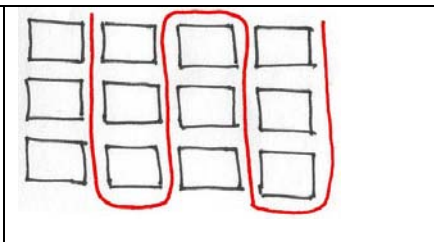
- The water or glycerol is used under pressure.
- No leakage may occur.
- The connecting takes place on the roof, so the possibilities to use tools are limited.
- Aesthetically the panels should be close together, but looking at installation the panels should be separated to give the installer space to connect the panels.
- The water or glycerol must flow through all panels and back to the beginning point (to go through the roof).
- The panels are preferably used in landscape and portrait orientation.
- The installer does not have to puzzle to get the panels in the right order.
- Tubes are as much as possible within the panels to prevent heat losses and easy damaging.
- Prevent 'dead ends' in the panel, where the water stands still.

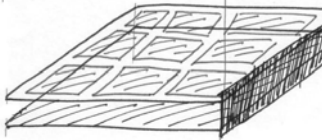
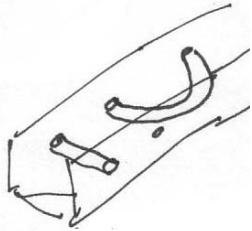
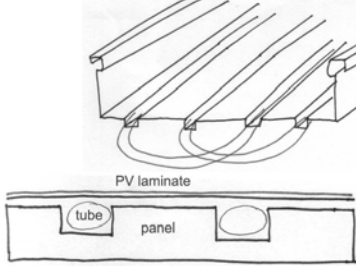
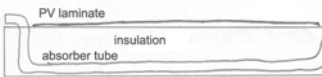
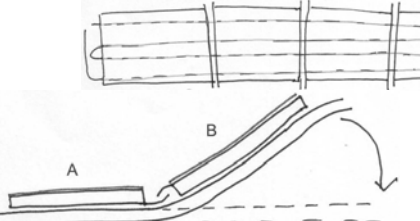
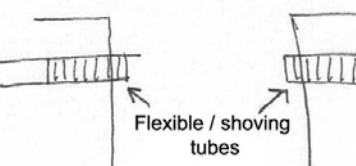
How can the panels be thermally connected?		
		
<p>Standard plumber parts connect tubes without using tools.</p>	<p>Standard plumber parts connect tubes with a pincers.</p>	<p>Connecting ring is rotated from one tube to another to make the connection.</p>
		
<p>Water flows through the tubes, which stretch out on one side of the panel.</p>	<p>A limited number of panels makes the connection easy and matches the yield of current solar thermal panels.</p>	<p>Special panels are used to turn the water flow.</p>
		
<p>An extra tube outside the panels is used to turn the water flow.</p>	<p>Flexible connection points give more possibilities to connect the panels in different configurations.</p>	<p>A long flexible tube can be placed between PV squares on a watertight underground. No thermal connections are needed anymore.</p>

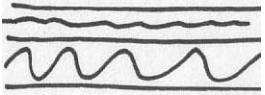
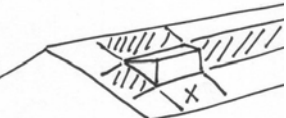
		
<p>Water flows between the PV laminate and a black absorber plate (no tubes).</p>	<p>The tubes are collected and connected in a shared frame.</p>	<p>A flexible tube is placed in long plastic panels with small gutters. The panels can be cut to the right size.</p>
		
<p>Tubes enter the panel on the top side, giving much space for connecting.</p>	<p>Panel B clicks onto panel A. After flexible tubes are connected to the lower side of panel B, it is flipped over to be connected to the roof.</p>	<p>The end of the tubes are flexible, so they can easily be connected, after which the panels can be shoved together.</p>

<p>Others</p> 			
<p>Transparent water flow makes functioning visible</p>	<p>Panels next to skylights</p>	<p>Matching PV cells in skylight</p>	

Appendix F. Simulation of different PVT principles

This table sums up the material properties and constant parameters used in the simulations of section 7.3.

Panel settings

Absorber area	A_c	4	m ²
Collector length	L_c	2	m
Ambient temperature	T_a	20	°C
Absorption factor	α_{abs}	0.84	-
Emissivity of absorber	ϵ_{abs}	0.9	-
Emissivity of glass	ϵ_{glass}	0.9	-
PV nominal efficiency	$\eta_{pv,nom}$	0.15	-
PV temperature dependency	$\beta_{pv,ref}$	0.0045	-
Transmission absorption coefficient through glass	τ_{glass}	0.92	-
Transmission absorption coefficient through PC	τ_{pc}	0.89	-
View factor earth	F_{earth}	0.15	-
View factor sky	F_{sky}	0.85	-

Flow rate	\dot{m}	50	l/h m ²
Thickness of copper absorber	δ_{cu}	0.2	mm
Thickness of PV cells	δ_{si}	0.35	mm
Thickness of PV glass	δ_{glass}	3.0	mm
Thickness of top glass	δ_{glass}	3.2	mm
Thickness of air layer	δ_{air}	20	mm
Tube inner diameter	D_{in}	8	mm
Tube outer diameter	D_{out}	10	mm
Tube spacing	W	9.5	mm
Heat conduction through air	k_{air}	0.025	W/m K
Heat conduction through copper	k_{cu}	390	W/m K
Heat conduction through glass	k_{glass}	0.9	W/m K
Heat conduction through PV	k_{si}	84	W/m K
Heat conduction through water	k_{water}	0.6	W/m K
Heat transfer cells to absorber (sheet-and-tube absorber)	$h_{cell-abs}$	250	W/m ² K
Heat transfer absorber to water (channel absorber)	$h_{abs-water}$	100	W/m ² K
Heat transfer through back of the panel	h_{insul}	1	W/m ² K

System settings

Tank volume	V_{tank}	0.2	m ³
Maximum temperature of water in tank	$T_{tank,max}$	90	°C
Temperature around the tank	$T_{tank,amb}$	15	°C
Temperature tap water	$T_{tapwater}$	60	°C
Temperature cold water	T_{cold}	10	°C
Efficiency heat exchanger	η_{hx}	0.80	-
Heat losses from tank	$h_{tank,loss}$	0.4	W/m ² K
Heat losses from pipes	$h_{pipe,loss}$	2.5	W/K

Materials and costs

Density copper	ρ_{cu}	8960	kg/m ³
Density PE	ρ_{pe}	930	kg/m ³
Density PV	ρ_{si}	2330	kg/m ³
Density glass	ρ_{glass}	2500	kg/m ³
Density air	ρ_{lucht}	1.293	kg/m ³
Density insulation	ρ_{insul}	25	kg/m ³
Thickness insulation	δ_{insul}	60	mm
Price glass	$euros_{glass}$	8	euros/m ²
Price insulation	$euros_{insul}$	5	euros/m ²
Price PV	$euros_{pv}$	350	euros/m ²
Price copper	$euros_{cu}$	5	euros/kg
Price PE	$euros_{pe}$	0.5	euros/kg

Appendix G. SUNTECH PV cells characteristics



STP210 - 18/Ub -1
 STP200 - 18/Ub -1
 STP190 - 18/Ub -1

Electrical Characteristics

Characteristics	STP210-18/Ub-1	STP200-18/Ub-1	STP190-18/Ub-1
Open - Circuit Voltage (Voc)	33.6V	33.4V	33V
Optimum Operating Voltage (Vmp)	26.4V	26.2V	26V
Short - Circuit Current (Isc)	8.33A	8.12A	7.89A
Optimum Operating Current (Imp)	7.95A	7.63A	7.31A
Maximum Power at STC (Pmax)	210Wp	200Wp	190Wp
Operating Temperature	-40°C to +85°C	-40°C to +85°C	-40°C to +85°C
Maximum System Voltage	600V DC	600V DC	600V DC
Maximum Series Fuse Rating	20AMPS	20AMPS	20AMPS
Power Tolerance	±3 %	±3 %	±3 %

STC: Irradiance 1000W/m², Module temperature 25°C, AM=1.5

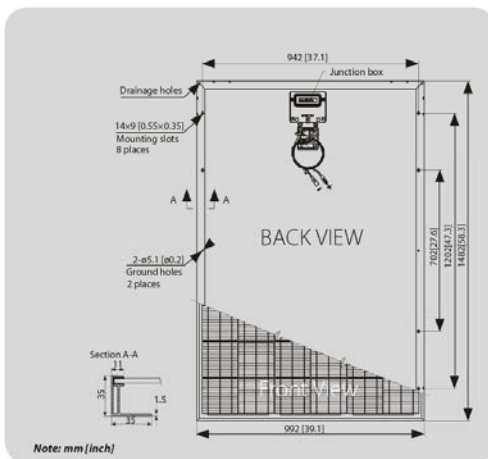

Mechanical Characteristics

Solar Cell	Poly-crystalline 156x156mm (6inch)
No. of Cells	54 (6x9)
Dimensions	1482x992x35mm (58.3x39.1x1.4inch)
Weight	16.8kg (37.0lbs.)
Front Glass	3.2 mm (0.13inch) tempered glass
Frame	Anodized aluminium alloy
Junction Box	IP65 rated
Output Cables	LAPP (4.0mm ²), asymmetrical lengths (-) 1200mm (47.2inch) and (+) 800mm (31.5inch), MC Plug Type IV connectors

Temperature Coefficients

Nominal Operating Cell Temperature (NOCT)	45°C±2°C
Temperature Coefficient of Pmax	-0.47 ± 0.05 %/°C
Temperature Coefficient of Voc	-0.34 ± 0.01 %/°C
Temperature Coefficient of Isc	(0.055 ± 0.01) %/°C

Current-Voltage & Power-Voltage Curve (200W)

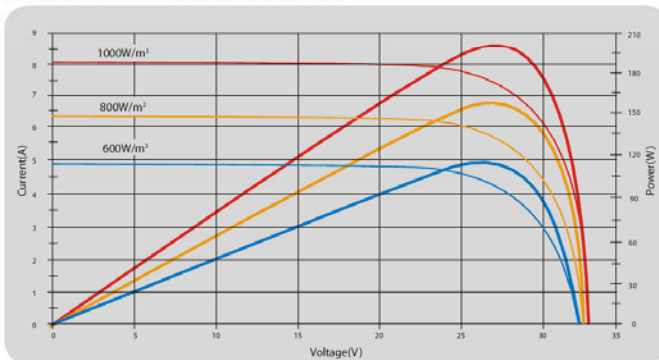

Temperature Dependence of Isc, Voc, Pmax

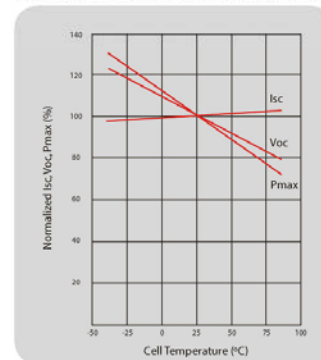

www.suntech-power.com | E-mail:sales@suntech-power.com

STP-DS-STD-N01.01 Rev 2008

Reference:

Suntech Power, 2008, *STP200 - 18/Ub*,
www.suntech-power.com/products/docs/STP200_18Ub-1.pdf (accessed 09-02-2009)

Appendix H. Anthropometric analyses for installation

To determine the width of the panels, so that the panels can comfortably be lifted, the anthropometric dataset 'Dutch adults', Population 'DINED 2004 (20-60 years)' is used. The measure for comfortable lifting is chosen from fist to fist while the arms are positioned horizontally, as shown in Figure 110. Since installers are mostly men, it is decided that 99% of all men should be able to lift the panel comfortably. Therefore, the data of P_1 men will be used.

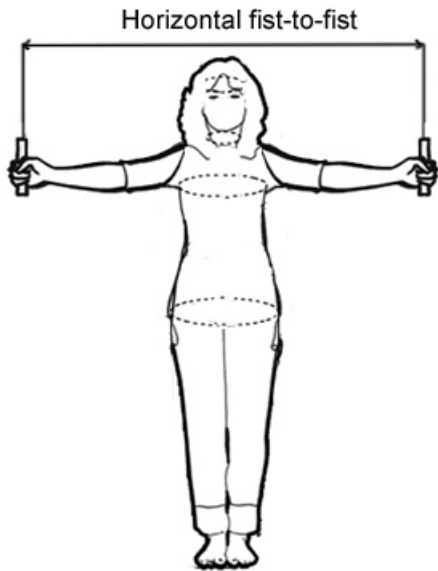

Figure 110: Measure for comfortable lifting

The measure needed is calculated by the following equation:

$$\begin{aligned}\text{Horizontal fist-to-fist} &= \text{shoulder breadth} + \text{shoulder height} - \text{fist height} \quad (24) \\ &\text{standing} \\ &= 413 + 1317 - 708 = 1022 \text{ mm}\end{aligned}$$

So, the maximum measure for comfortable lifting is 1022 mm. The panel's width should be equal or smaller than this measure.

Reference:

- DINED, 2004, *Dataset 'Dutch adults', Population 'DINED 2004 (20-60 years)'*, <http://dined.io.tudelft.nl/en,dined2004,304>, (accessed 10-02-2009)